



Product Information Guide

CUSTOMER SUCCESS AND SALES SUPPORT

Table of contents

Contacts & Digital Assets	3
Brand	4
Parts and Accessories	8

Bowriders

M15	9
M17	12
M19	15
VR 4, I/O and OB	18
VR 5, I/O and OB	21
VR 6, I/O and OB	24

Deck boats

DX2000, OB	27
DX2050, I/O	30
DX2200, OB	33
DX2250, I/O	36

Center consoles

T18 Bay	39
Trophy 20 CC/CX	42
Trophy 22 CC/CX	45
Trophy 24CC	48

Who to contact

Warranty

For warranty inquiries, claims, ownership/registration, labor rate affidavits & inquiries, please email warranty@bayliner.com

Part Orders

For part order inquiries and part number research, please contact parts@bayliner.com

Troubleshooting

For pre-authorizations and troubleshooting, please contact techsupport@bayliner.com

Digital assets

Marketing resources

Bayliner's Digital Asset Library provides a host of resources you can utilize to engage your customers with compelling branded content and up-to-date product information. Visit the Digital Asset Library for product spec sheets, catalogs, POP materials and other brand assets at marketing.bayliner.com.

Bayliner image gallery

This is Bayliner's easy-to-use online archive of product and lifestyle imagery. The Image Gallery houses three years' worth of product shots, as well as editorial images—all available for download and use for your marketing purposes at bayliner.smugmug.com.

Bayliner on social media

Bayliner has an ever-growing presence on Facebook, YouTube, TikTok and Instagram, with over 100,00 fans on Facebook alone.

facebook.com/baylinerboats
youtube.com/user/baylinerboating
tiktok.com/@baylinerboats
instagram.com/baylinerboats
youtube.com/@bayliner

What is Bayliner all about?



Bowriders

Proven
Stylish
Value

- ...Leading runabout brand for more than 65 years
- ...Sporty design and well-appointed interior
- ...More boat for your money, with interior space, storage and features

Deck Boats

Stable
Social
Versatile
Value

- ...Wide beam provides exceptional stability
- ...Spacious layout for passengers, gear and entertaining
- ...Configurations allow you to cruise, cove, fish or enjoy tow sports
- ...More interior space, storage and amenities for your money

Center Consoles

Versatile
Easy
Affordable

- ...The fishable platform can also be used for tow sports or cruising
- ...Easy to operate, launch/retrieve, trailer, and maintain
- ...Priced for mass appeal

Our brand

Affordable

Bayliner is the value leader in recreational boating.

BENEFITS:

Easy to purchase
Feature/price balance

Widely Known

Bayliner has been putting families around the world on the water for more than 65 years.

BENEFITS:

Peace of mind
Enhanced resale value

Intuitive

Bayliner designs products that are usable and inviting to boaters of all skill levels.

BENEFITS:

Ease of use
Multi-use

Fit for Purpose

Bayliner serves owners who simply love spending time on the water with family and friends.

BENEFITS:

Multi-year CSI Award recipient
Industry leading warranty coverage



Our dealers

Professionalism

Nurture a reputation in your community as good people to do business with.

FOCUS:

Facility is clean, inviting and fully featured
Staff is courteous, knowledgeable and attentive

Visible

Foster community connection through all walks of life to grow your business, your people and your customer base.

FOCUS:

Digitally proficient
Promotionally driven
Event-minded

Customer experience

Respect for the customer balanced with an attitude of fairness that nurtures our mutual business relationship.

FOCUS:

Listen
Follow up and through



Our people

Winning attitude

A mindset that going above and beyond is standard operating procedure.

ATTRIBUTES:

Positive attitude
Can-do approach

Relationship

Communication creates a human connection.

ATTRIBUTES:

Ability to build rapport
Humble and empathetic

Professionalism

Conduct yourself according to the Golden Rule:
Treat others the way you would like to be treated.

ATTRIBUTES:

Courteous
Respectful

Customer service

Respect for the customer balanced with an attitude of fairness that nurtures our mutual business relationship.

ATTRIBUTES:

Active listener
Successful follow-up and follow through



Parts and accessories

Bayliner offers a wide variety of optional parts and accessories for each boat model. Some are available as an option with the boat at the time of manufacture, others are available at a later date through our Parts Department. Our Parts Department also exclusively offers specialized options for several models. A list of the available options is provided by model in this handbook. Dealers can order Parts & Accessories through COMPASS > Parts > Orders

Questions/comments? Please contact our **Customer Service Department** at **(865) 971-6232** or through the toll-free parts and service line we have established for your territory.

Deck boat, optional add-ons



Bimini top



Bow filler cushions



Ski pylon, outboard models only



Portable head



Extended swim platform (sterndrive models only)



Premium upholstery



Bow table



Bow wind block (requires bow filler cushion)

Bowrider, optional add-ons



Bimini top



Bow filler cushions



Bow well and cockpit cover



Cockpit table



Extended swim platform, sterndrive models only



Coastline upholstery



ProArc Tower

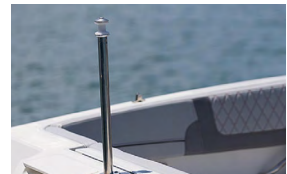

Ski pylon, outboard models only



Windshield with opening center panel



Digital dash w/USB and charging ports



M15

 **BAYLINER™**

LENGTH OVERALL (LOA)	15' 2"	4.6 M
WIDTH (BEAM)	6' 7"	2 M
MAX PEOPLE CAPACITY	5	5
MAX HORSEPOWER	60 HP	60 HP
DEADRISE	17°	17°
APPROX WEIGHT W/ STANDARD ENGINE	1,385 LBS	628 KG
APPROX WEIGHT W/ TRAILER	1,755 LBS	796 KG
MAX PEOPLE WEIGHT	700 LBS	318 KG
FUEL CAPACITY	12 GAL	45 L
DRAFT DOWN	2' 1"	0.61 M
HEIGHT ON TRAILER ¹	5' 9"	1.6 M
BEAM ON TRAILER	7' 1"	2.13 M
STORAGE LENGTH ²	17' 5"	5.3 M
BRIDGE CLEARANCE	3'	0.9 M

Specification dimensions are approximate and subject to variance.

¹ Tongue jack lowered all the way down.

² Stern drive in down position and trailer tongue swung to side.

Colors, graphics and some equipment shown, subject to change without notice.

Standard features

Electrical

Bilge Pump (Automatic)

Cockpit

Cup Holders (5)
Grab Handles (3)
Mooring Cleats (4)

Engine

40 HP Mercury® Fourstroke ELPT

Helm

Dual Purpose Gauge: Speedometer, Voltmeter
12V Accessory Outlet
12V Horn
Side-Mounted Engine Controls w/ Trim & Tilt Switch In Handle
Custom Sport Steering Wheel

Hull & Deck

Bow & Transom Eyes (3)
12V Navigation Lights
M-Hull Design for Added Stability
Fiberglass Floor Liner
Helm Windscreen
Swim Platform w/ Telescoping Ladder

Trailer

Single Axle Painted Trailer w/ Swing Tongue (Black)



Exterior color

- Solid White Hull
- Solid Rally Red hull
- Solid Black hull

Interior color

- Gray w Black accent
- Gray w Red accent



Optional add-on

- 50 HP Mercury Fourstroke ELPT
- 60 HP Mercury® FourStroke ELPT
- VesselView® Mobile
- High Altitude Prop
- Ski Tow Pylon
- Cockpit Flooring (Gray Mat) ★
- Single Axle Galvanized Trailer

MX Package

Includes Standard Features plus:

- Waterproof 120-Watt AM/FM Stereo w/ Bluetooth Capability ★
- Bimini, 6' Top w/ Boot ★
- Mooring Cover ★

M Comfort Package

Includes Standard Features plus:

- Bow Filler Cushion ★
- Digital Depth Indicator
- Portside Lounge Seat
- Stainless Steel Package (Cup Holders, Grab Rails, Fuel Fill, Thru Hull, Horn Vent, Bow Hatch, Latches, Rub Rail)



M15



Features

1. Simple and intuitive helm controls
2. Lightweight model for easy storage, trailering and handling
3. Nook-style cockpit configuration, optimized for socializing seating
4. Beam forward design allowing more room for passenger comfort and storage
5. Premium stitched upholstery
6. Molded-in storage and cup holders
7. Award-winning Mercury® engine performance and reliability
8. Filler cushion turns bow into a sun lounger
9. M-Hull foundation that allows ease on and off trailer due to M-Hull design and trailer bunks configuration.





M17

 **BAYLINER™**

LENGTH OVERALL (LOA)	17' 0"	5.18 M
WIDTH (BEAM)	7' 6"	2.30 M
MAX PEOPLE CAPACITY	7	7
MAX HORSEPOWER	90 HP	90 HP
DEADRISE	16°	16°
APPROX WEIGHT W/ STANDARD ENGINE	1,984 LBS	900 KG
APPROX WEIGHT W/ TRAILER	2,457 LBS	1,115 KG
MAX PEOPLE WEIGHT	1,000 LBS	454 KG
FUEL CAPACITY	18 GAL	72 L
DRAFT DOWN	2' 3"	0.61 M
HEIGHT ON TRAILER ¹	6' 8"	1.83 M
BEAM ON TRAILER	8' 3"	2.51 M
STORAGE LENGTH ²	20' 1"	6.10 M
BRIDGE CLEARANCE W/ OPTIONS	3' 5"	1.06 M

Specification dimensions are approximate and subject to variance.

¹ Tongue jack lowered all the way down.

² Stern drive in down position and trailer tongue swung to side.

Colors, graphics and some equipment shown, subject to change without notice.

Standard features

Electrical

Battery Switch
Bilge Pump (Automatic)

Cockpit

Cup Holders (9)
Grab Handles (4)
Mooring Cleats (4)

Fuel

18 Gal Internal Tank w/ Integrated Vent

Engine

60 HP Mercury® FourStroke EFI Outboard

Helm

Multi-Purpose Gauge: Speedometer, Voltmeter, Fuel
12V Accessory Outlet
12V Horn
Side-Mounted Engine Controls w/ Trim & Tilt Switch In Handle
Custom Sport Steering Wheel

Hull & Deck

Bow & Transom Eyes (3)
12V Navigation Lights
M-Hull Design for Added Stability
Fiberglass Floor Liner
Single Helm Windscreen
Swim Platform w/ Telescoping Ladder

Trailer

Single Axle Painted Trailer w/ Swing Tongue (Black)



Exterior color

- Solid White Hull
- Solid Rally Red hull
- Solid Impulse Blue hull
- Solid Black hull

Interior color

- Gray w Black accent
- Gray w Blue accent
- Gray w Red accent



Optional add-ons

OB Engines

- 60 HP Command Thrust Fourstroke Outboard (Black)
- 75 HP Mercury® FourStroke EFI Outboard
- 90 HP Mercury® FourStroke EFI Outboard

Convenience Options

- Dual Acrylic Windscreen
- High Altitude Prop
- VesselView® Mobile
- Hydraulic Steering
- Full Windshield w/ Opening CTR Panel

Floor Covering

- Cockpit Flooring Mat (Gray) ★

Water Sports

- Ski Tow Pylon ★

Trailer

- Single Axle Galvanized Trailer

MX Package

Includes Standard Features plus:

- Bimini, 6' Top w/ Boot
- Waterproof 120-Watt AM/FM Stereo W/ Bluetooth
- Snap-On Bow Well & Cockpit Cover ★

M Comfort Package

Includes Standard Features plus:

- Bow Filler Cushion
- Digital Depth Indicator ★
- Bow Speakers (2)
- Stainless Steel Package (Cup Holders, Grab Rails, Fuel Fill, Thru Hull, Horn Vent, Bow Hatch, Latches, Rub Rail)
- Bow Block-Off
- Portside Lounge Seat
- Cooler
- Cockpit Table





Features

1. Simple and intuitive helm controls
2. Lightweight model for easy storage, trailering and handling
3. Nook-style cockpit configuration, optimized for socializing seating
4. Beam forward design allowing more room for passenger comfort and storage
5. Premium stitched upholstery
6. Molded-in storage and cup holders
7. Award-winning Mercury® engine performance and reliability
8. Filler cushion turns bow into a sun lounger
9. M-Hull foundation that allows ease on and off trailer due to M-Hull design and trailer bunks configuration
10. Integrated cooler





M19

 **BAYLINER™**

LENGTH OVERALL (LOA)	19' 0"	5.79 M
WIDTH (BEAM)	7' 6"	2.24 M
MAX PEOPLE CAPACITY	9	9
MAX HORSEPOWER	115 HP	115 HP
DEADRISE	15°	15°
APPROX WEIGHT W/ STANDARD ENGINE	2,399 LBS	1,088 KG
APPROX WEIGHT W/ TRAILER	3,009 LBS	1,365 KG
MAX PEOPLE WEIGHT	1,300 LBS	600 KG
FUEL CAPACITY	18 GAL	68 L
DRAFT DOWN	2' 1"	0.64 M
HEIGHT ON TRAILER ¹	6' 4"	1.93 M
BEAM ON TRAILER	8' 6"	2.59 M
STORAGE LENGTH ²	21' 6"	6.55 M
BRIDGE CLEARANCE W/ OPTIONS	5' 9"	1.79 M

Specification dimensions are approximate and subject to variance.

¹ Tongue jack lowered all the way down.

² Outboard motor in down position and trailer tongue swung to side.

Colors, graphics and some equipment shown, subject to change without notice.

Standard features

Electrical

Battery Switch
Bilge Pump (Automatic)

Cockpit

Cup Holders (6)
Grab Handles (4)
Mooring Cleats (4)

Engine

90 HP Mercury® FourStroke EFI Outboard

Helm

Multi-Purpose Gauge: Speedometer, Voltmeter, Fuel
12V Accessory Outlet
12V Horn
Side-Mounted Engine Controls w/ Trim & Tilt Switch In Handle
Custom Sport Steering Wheel

Hull & Deck

Bow & Transom Eyes (3)
12V Navigation Lights
M-Hull Design for Added Stability
Fiberglass Floor Liner
Single Helm Windscreen
Swim Platform w/ Telescoping Ladder
Single Windscreen
Ski Locker
Bucket Helm Seat
Portside Under Seat Storage

Trailer

Single Axle Painted Trailer w/ Swing Tongue (Black)



Exterior color

- Solid White Hull
- Solid Rally Red hull
- Solid Impulse Blue hull
- Solid Black hull

Interior color

- Gray w Black accent
- Gray w Blue accent
- Gray w Red accent



Optional add-ons

OB Engines

- 115 HP Mercury® FourStroke EFI Outboard
- 115 HP Mercury Pro XS

Windscreen / Windshield

- Dual Windscreen (acrylic)
- Split Windshield with Center Panel

Convenience Options

- High Altitude Prop
- VesselView® Mobile
- Hydraulic Steering

Floor Covering

- Cockpit Flooring Mat (Gray) ★

Water Sports

- Ski Tow Pylon ★

Trailer

- Single Axle Galvanized Trailer

MX Package

Includes Standard Features plus:

- Bimini, 6' Top w/ Boot
- Waterproof 120-Watt AM/FM Stereo w/ Bluetooth
- Snap-On Bow Well & Cockpit Cover ★

M Comfort Package

Includes Standard Features plus:

- Cooler
- Stainless Steel Package (Cup Holders, Grab Rails, Fuel Fill, Thru Hull, Horn Vent, Bow Hatch, Latches, Rub Rail)
- Bow Filler Cushion
- Bow Block-Off (Requires Bow Filler Cushion)
- Bow Speakers (2)
- Cockpit Table
- Digital Depth Indicator
- Portside Lounge Seat
- Portside Storage Door





Features

1. Simple and intuitive helm controls
2. Lightweight model for easy storage, trailering and handling
3. Nook-style cockpit configuration, optimized for socializing seating
4. M-Hull foundation offers better stability and predictable handling
5. Premium stitched upholstery
6. Molded-in storage and cup holders
7. Award-winning Mercury® engine performance and reliability
8. Filler cushion turns bow into a sun lounger
9. Adjustable aft lounge
10. M-Hull foundation that allows ease on and off trailer due to M-Hull design and trailer bunks configuration
11. Ski locker





VR4

 **BAYLINER™**

LENGTH OVERALL (LOA), I/O & OB	18' 9"	5.7 M
WIDTH (BEAM)	7' 6"	2.8 M
MAX PEOPLE CAPACITY	7	7
I/O, MAX HORSEPOWER	200 HP	200 HP
OB, MAX HORSEPOWER	150 HP	200 HP
DEADRISE	19°	19°
APPROX WEIGHT W/ STANDARD ENGINE	2,822 LBS	1,280 KG
MAX PEOPLE WEIGHT	1,155 LBS	524 KG
FUEL CAPACITY	33 GAL	125 L
DRAFT DOWN	2' 10"	0.86 M
BEAM ON TRAILER	8' 6"	2.6 M

Specification dimensions are approximate and subject to variance.
Colors, graphics and some equipment shown, subject to change without notice.

Standard features

Electrical

Battery Switch
Automatic Bilge Pump
12V Blower

Cockpit

Standard Speakers (4)
Cup Holders (6)
Mooring Cleats (4)
Fuel Fill w/ Integrated Vent
Glove Box
Helm Seat w/ 180 Degree Swivel
In-Floor Ski/Wakeboard Storage
Waterproof 120-Watt AM/FM Stereo
w/Bluetooth Capability

Trailer

Single Axle Painted Trailer w/Brakes
and Swing Tongue (Black)

Engine

200 HP MerCruiser® ECT 4.5L MPI Sterndrive (Alpha 1 Outdrive), I/O
115 HP Mercury® FourStroke EFI Outboard, OB

Helm

Multi-Function Gauges w/Fog Resistant Glass Lenses:
Fuel, Speedometer, Tachometer, Voltmeter
12V Accessory Outlet
12V Horn
Side-Mounted Engine Controls w/Trim & Tilt Switch in Handle
Tilt Steering
Custom Sport Steering Wheel
Mechanical Cable Steering (Outboard Models)
Analog Trim Indicator
Sport Windshield w/Opening Center Panel

Hull & Deck

Bow & Transom Eyes (3)
12V Navigation Lights
Fiberglass Floor Liner
Sport Windshield w/Opening Center Panel
Swim Platform w/Telescoping Ladder
V-Hull for Added Performance



Exterior color

- Solid White Hull
- Solid Rally Red hull
- Solid Black hull
- Solid Blue hull
- Solid Gray hull
- VR Sport Package (Red)
- White bottom w/ Rally Red hull
- White bottom w/ Black hull
- White bottom w/ Blue hull
- White bottom w/ Gray hull
- Impulse Blue w/ White hull
- VR Sport Package (Blue)

Interior color

- Graphite (Gray)
- Coastline (Tan)
- Gray/White

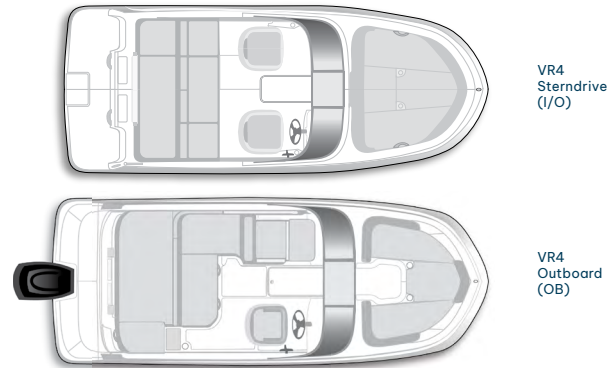

Optional add-ons

I/O Engines

- 200 HP MerCruiser® ECT 4.5L MPI Sterndrive (Alpha 1 Outdrive)
- 200 HP MerCruiser® 4.5L MPI Sterndrive (Alpha 1 Outdrive)*

OB Engines

- 115 HP Mercury® FourStroke Command Thrust EFI Outboard
- 115 HP Mercury® Pro XS XL Command Thrust Outboard
- 150 HP Mercury® FourStroke EFI Outboard
- Hydraulic Steering System (115 HP and Below)

Tops

- Bimini, 6' Top w/Boot ★
- ProArc Tower
- Tower Speaker Option

Canvas

- Snap-On Bow Well & Cockpit Cover ★

Windshield

- Windshield w/Opening Center & Side Wings

Floor Covering

- Cockpit Flooring Mat (Gray) ★
- Cockpit Flooring Mat (Tan) ★
- Woven Floor Covering (Gray)
- Woven Floor Covering (Tan)

Seats & Upholstery

- Bow Filler Cushion
- Aft Filler Cushion (OB Only)

Sound System

- Rockford Fosgate® System (4-speaker) ★

Appearance Package

- Stainless Steel Package (Cup Holders, Fuel Fill, Thru Hull, Horn Vent, Bow Hatch, Latches, Rub Rail)

Lighting

- Exterior Lighting (LED Docking Lights, 2x Rear Underwater Lights)
- Interior Lighting

Water Sports

- Wakeboard Rack (1)
- Wakeboard Rack (2)
- Ski Tow Pylon (OB Only)

Swim Platforms

- Swim Platform Mat (Gray)
- Swim Platform Mat (Teak)

Convenience Options

- Cockpit Table
- Digital Depth Indicator ★
- High Altitude Prop
- Bow Wind Block (Requires Bow Filler Cushion)
- VesselView® Mobile
- Dual Battery Trays w/Switch
- 7" Digital Dash w/Engine Data
- Wireless Phone Charger

Trailer

- Single Axle Painted Trailer w/ Brakes & Swing Tongue
- No Trailer

★ Popular option

* CANADA AND INTERNATIONAL ONLY





Engine performance data

Outboard

115 HP Mercury® FourStroke EFI Outboard

Cruise mph	28.6
WOT mph	43
Propeller	19 P Black Max
Range	N/A
Weight as tested	3,250 lbs

Stern drive

200 HP MerCruiser® ECT 4.5L MPI Stern drive (Alpha 1 Outdrive)

Cruise mph	34.2
WOT mph	53
Propeller	19 P Black Max
Range	N/A
Weight as tested	3,450 lbs

This information is provided for comparison purposes and is intended to show relative performance between different boats and engine options. A specific boat's performance will be affected by water and weather conditions, altitude, condition of boat, actual load, engine and propeller. Engine performance data is based on boat in cruise load weight condition. Cruise load weight condition consists of boat with typical options, full tanks, all safety gear, two passengers and typical storage. Cruising range based on cruise speed at cruise load with 10% fuel reserve at rated range.

Features

1. Simple and intuitive helm controls
2. Lightweight model for easy storage, trailering and handling
3. Spacious cockpit for socializing
4. V-Hull allows for a smooth ride with higher speed and improved performance
5. High attention to detail, fit and finish with premium stitched upholstery
6. Molded-in storage and cup holders
7. Award-winning Mercury® engine performance and reliability
8. Filler cushion turns bow into a sun lounger
9. Large sunpad





VR5

 **BAYLINER™**

LENGTH OVERALL (LOA), I/O & OB	20' 7"	6.09 M
WIDTH (BEAM)	8' 0"	2.43 M
MAX PEOPLE CAPACITY, I/O	8	8
MAX PEOPLE CAPACITY, OB	9	9
MAX HORSEPOWER, I/O	250 HP	250 HP
MAX HORSEPOWER, OB	200 HP	250 HP
DEADRISE	20°	20°
MAX PEOPLE WEIGHT, I/O	1,323 LBS	600 KG
MAX PEOPLE WEIGHT, OB	1,537 LBS	697 KG
FUEL CAPACITY	33 GAL	125 L
DRAFT DOWN	2' 8"	0.6 M
BEAM	8' 0"	2.43 M
BEAM ON TRAILER	8' 6"	2.6 M

Specification dimensions are approximate and subject to variance.
Colors, graphics and some equipment shown, subject to change without notice.

Standard features

Electrical

Automatic Bilge Pump
12V Blower

Cockpit

Integrated Cooler
Speakers (4)
Cup Holders (5)
Grab Handles (5)
Mooring Cleats (6)
Fuel Fill w/ Integrated Vent
Glove Box
Helm Seat w/ 180 Degree Swivel
In-Floor Ski/Wakeboard Storage
Waterproof 120-Watt AM/FM Stereo
w/Bluetooth Capability

Engine

200 HP MerCruiser® ECT 4.5L MPI Sterndrive (Alpha 1 Outdrive), I/O
115 HP Mercury® FourStroke EFI Outboard, OB

Helm

Multi-Function Gauges w/ Fog Resistant Glass Lenses: Fuel, Speedometer, Tachometer, Voltmeter
12V Accessory Outlet
12V Horn
Side-Mounted Engine Controls w/ Trim & Tilt Switch in Handle
Tilt Steering
Custom Sport Steering Wheel
Analog Trim Indicator

Hull & Deck

Bow & Transom Eyes (3)
12V Navigation Lights
Stainless Steel Tow Ring (I/O Only)
Fiberglass Floor Liner
Sport Windshield w/ Opening with Central Panel
Swim Platform w/ Telescoping Ladder
V-hull for Added Performance

Trailer

Single Axle Painted Trailer w/ Brakes and Swing Tongue (Black)



Exterior color

- Solid White Hull
- Solid Rally Red hull
- Solid Black hull
- Solid Blue hull
- Solid Gray hull
- VR Sport Package (Red)
- White bottom w/ Rally Red hull
- White bottom w/ Black hull
- White bottom w/ Blue hull
- White bottom w/ Gray hull
- Impulse Blue w/ White hull
- VR Sport Package (Blue)

Interior color

- Graphite (Gray)
- Coastline (Tan)
- Gray/White

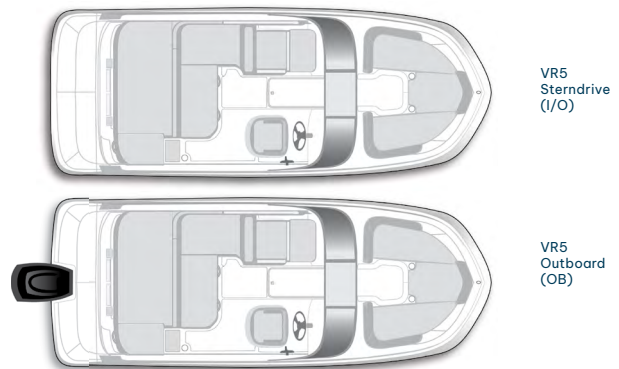

Optional add-ons

I/O Engines

- 200 HP MerCruiser® ECT 4.5L MPI Sterndrive (Alpha 1 Outdrive)
- 250 HP MerCruiser® ECT 4.5L MPI Sterndrive (Alpha 1 Outdrive)
- 200 HP MerCruiser® 4.5L MPI Sterndrive (Alpha 1 Outdrive)*
- 250 HP MerCruiser® 4.5L MPI Sterndrive (Alpha 1 Outdrive)*

OB Engines

- 115 HP Mercury® FourStroke CommandThrust EFI Outboard
- 115 HP Mercury® Pro XS XL Outboard
- 150 HP Mercury® FourStroke EFI Outboard

Tops

- Bimini, 6' Top w/ Boot ★
- ProArc Tower w/ Integrated Top
- Tower Speaker Option

Canvas

- Snap-On Bow Well & Cockpit Cover ★
- Privacy Curtain OB only

Windshield

- Windshield w/ Opening Center & Side Wings

Floor Covering

- Cockpit Flooring (Gray Mat) ★
- Cockpit Flooring (Tan Mat) ★
- Snap-In Seagrass Woven Floor Covering (Tan)
- Snap-In Seagrass Woven Floor Covering (Gray)
- Cockpit Carpet Runners

Seats & Upholstery

- Bow Filler Cushion

Sound System

- Rockford Fosgate® System (4-speaker) ★

Appearance Package

- Stainless Package (Cup Holders, Fuel Fill, Thru Hull, Horn Vent, Bow Hatch, Latches, Rub Rail)
- VR Sport Package (Blue)
- VR Sport Package (Red)

Lighting

- Exterior Lighting (LED Docking Lights, 2x Rear Underwater Lights)
- Interior Lighting

Water Sports

- Wakeboard Rack (1)
- Wakeboard Rack (2)
- Ski Tow Pylon (OB Only)

Swim Platforms

- Swim Platform Mat (Gray)
- Swim Platform Mat (Teak)

Convenience Options

- 7" Glass Dash Screen w/ Engine Data
- 9" Glass Dash Screen w/ Engine Data
- Wireless Phone Charger
- Cockpit Table
- Digital Depth Indicator ★
- Dual Battery Trays w/Switch
- High Altitude Prop
- Bow Wind Block (Requires Bow Filler Cushion)
- VesselView® Mobile

Trailer

- Single Axle Galvanized Trailer w/ Brakes & Swing Tongue
- Single Axle Painted Trailer w/ Brakes and Swing Tongue (Black)
- Tandem Axle Trailer w/ Brakes (Black)
- Tandem Axle Trailer w/ Brakes (Galv)

★ Popular option

* CANADA AND INTERNATIONAL ONLY





Engine performance data

Outboard

150 HP Mercury® FourStroke EFI Outboard

Cruise mph	35.4
WOT mph	53
Propeller	7 P Black Max
Range	N/A
Weight as tested	4,240 lbs

Sterndrive

250 HP MerCruiser® 4.5L MPI Sterndrive (Alpha 1 Outdrive)

Data Not Yet Available

200 HP MerCruiser® ECT 4.5L MPI Sterndrive (Alpha 1 Outdrive)

Cruise mph	34.2
WOT mph	47
Propeller	21 P Black Max
Range	109 nm
Weight as tested	4,028 lbs

This information is provided for comparison purposes and is intended to show relative performance between different boats and engine options. A specific boat's performance will be affected by water and weather conditions, altitude, condition of boat, actual load, engine and propeller. Engine performance data is based on boat in cruise load weight condition. Cruise load weight condition consists of boat with typical options, full tanks, all safety gear, two passengers and typical storage. Cruising range based on cruise speed at cruise load with 10% fuel reserve at rated range.

Features

1. Simple, intuitive controls at the helm
2. Lightweight model for easy storage, trailering and handling
3. Large cockpit with adjustable seating for entertaining or lounging
4. V-Hull allows for a smooth ride with higher speed and less splashing
5. Premium stitched upholstery
6. Molded-in storage and cup holders
7. Award-winning Mercury® engine performance and reliability
8. Filler cushion turns bow into a sun lounger
9. Large sunpad
10. Integrated ski locker
11. Flip up headrest





VR6

 **BAYLINER™**

LENGTH OVERALL (LOA), I/O & OB	22' 7"	6.9 M
WIDTH (BEAM)	8' 0"	2.44 M
MAX PEOPLE CAPACITY, I/O	10	10
MAX PEOPLE CAPACITY, OB	10	10
MAX HORSEPOWER, I/O	250 HP	250 HP
MAX HORSEPOWER, OB	200 HP	200 HP
DEADRISE	20°	20°
APPROX WEIGHT W/ STANDARD ENGINE	3,797 LBS	1,722 KG
MAX PEOPLE WEIGHT, I/O	1,700 LBS	771 KG
MAX PEOPLE WEIGHT, OB	1,654 LBS	750 KG
FUEL CAPACITY	33 GAL	125 L
BEAM ON TRAILER	8' 6"	2.6 M

Specification dimensions are approximate and subject to variance.
Colors, graphics and some equipment shown, subject to change without notice.

Standard features

Electrical

Battery Switch
Automatic Bilge Pump
12V Blower

Cockpit

Speakers (4), Cup Holders (6)
Grab Handles, Mooring Cleats (6)
Fuel Fill w/ Integrated Vent
Glove Box
Helm Seat w/ 180 Degree Swivel
In-Floor Ski/Wakeboard Storage
Portside Companion Seat (3-Position)
Large Lockable Port-Side Changing
Room and Storage Compartment
Self-Bailing Cockpit
Integrated Cooler
Waterproof 120-Watt AM/FM Stereo
w/ Bluetooth Capability

Engine

200 HP MerCruiser® ECT 4.5L MPI Sterndrive (Alpha 1 Outdrive), I/O
150 HP Mercury® FourStroke EFI Outboard, OB

Helm

Multi-Function Gauges w/ Fog Resistant Glass Lenses
12V Accessory Outlet
12V Horn
Side-Mounted Engine Controls w/ Trim & Tilt Switch in Handle
Tilt Steering
Custom Sport Steering Wheel
Analog Trim Indicator

Hull & Deck

Bow & Transom Eyes (3)
12V Navigation Lights
Stainless Steel Tow Ring (I/O only)
Fiberglass Floor Liner
Sport Windshield w/ Opening Center Panel
Swim Platform w/ Telescoping Ladder
V-Hull for Added Performance

Trailer

Tandem Axle Painted Trailer w/ Brakes & Swing Tongue (Black)



Exterior color

- Solid White Hull
- Solid Rally Red hull
- Solid Black hull
- Solid Blue hull
- Solid Gray hull
- VR Sport Package (Red)
- White bottom w/ Rally Red hull
- White bottom w/ Black hull
- White bottom w/ Blue hull
- White bottom w/ Gray hull
- Impulse Blue w/ White hull
- VR Sport Package (Blue)

Interior color

- Graphite (Gray)
- Coastline (Tan)
- Gray/White

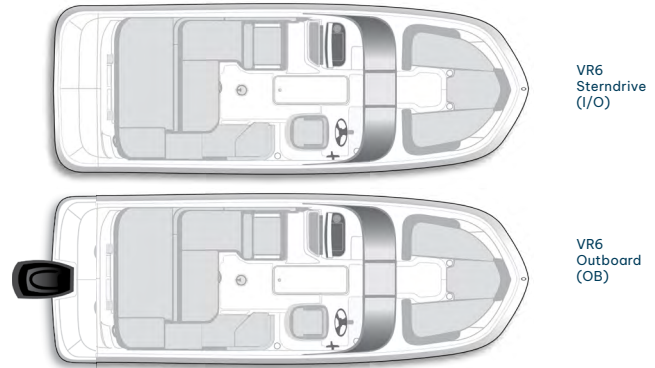

Optional add-ons

I/O Engines

- 200 HP MerCruiser® ECT 4.5L MPI Sterndrive (Alpha 1 Outdrive)
- 200 HP MerCruiser® 4.5L MPI Sterndrive (Alpha 1 Outdrive)*
- 250 HP MerCruiser® ECT 4.5L MPI Sterndrive (Alpha 1 Outdrive)
- 250 HP MerCruiser® 4.5L MPI Sterndrive (Alpha 1 Outdrive)*

OB Engines

- 200 HP Mercury® FourStroke Outboard (Black)
- High Altitude Prop

Steering

- Power Steering - 200HP L4 Option, OB

Tops

- Bimini, 6' Top w/ Boot ★
- ProArc Tower w/ Integrated Top
- Tower Speaker Option

Canvas

- Snap-On Bow Well & Cockpit Cover ★

Windshield

- Windshield w/ Opening Center & Side Wings

Floor Covering

- Cockpit Flooring (Gray Mat) ★
- Cockpit Flooring (Tan Mat) ★
- Snap-In Seagrass Woven Floor Covering (Tan)
- Snap-In Seagrass Woven Floor Covering (Gray)

Seats & Upholstery

- Bow Filler Cushion

Appearance Package

- Stainless Package
- VR Sport Package (Blue)
- VR Sport Package (Red)

Sound System

- Rockford Fosgate® System (4-speaker) ★

Lighting

- Exterior Lighting
- Interior Lighting

Water Sports

- Wakeboard Rack (1x)
- Wakeboard Rack (2x)
- Ski Tow Pylon (OB only)

Swim Platforms

- Swim Platform Mat (Gray)
- Swim Platform Mat (Teak)

Convenience Options

- 7" Glass Dash Screen w/ Engine Data
- 9" Glass Dash Screen w/ Engine Data
- Privacy Curtain
- Cockpit Table
- Digital Depth Indicator ★
- Portable Head
- Bow Wind Block (Requires Bow Filler Cushion)
- VesselView® Mobile
- Dual Battery Trays w/Switch
- Wireless Phone Charger

Trailer

- Tandem Axle Galvanized Trailer w/ Brakes & Swing Tongue
- Tandem Axle Painted Trailer w/ Brakes & Swing Tongue (Black)

★ Popular option

* CANADA AND INTERNATIONAL ONLY



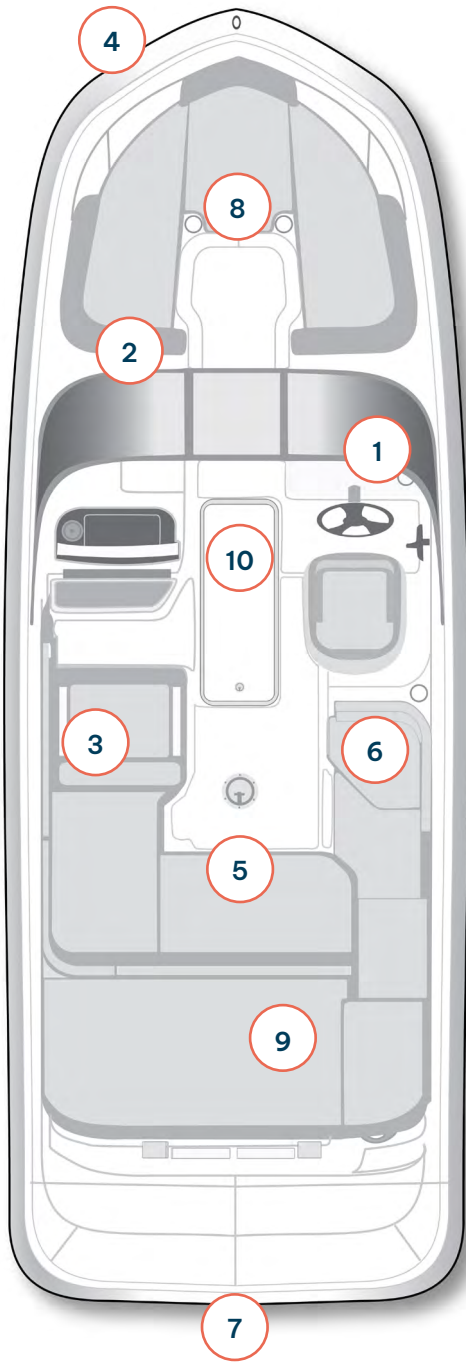

Engine performance data

Outboard

150 HP Mercury® FourStroke EFI Outboard

Data Not Yet Available

200 HP 4 Stroke L6 Verado

Data Not Yet Available

Sterndrive

200 HP MerCruiser® ECT 4.5L MPI Sterndrive (Alpha 1 Outdrive)

Cruise mph	32.8
WOT mph	45.8
Propeller	19 P Black Max
Range	104.3 nm
Weight as tested	4,430 lbs

250 HP Mercury 4.5L A1 Sterndrive

Cruise mph	32.3
WOT mph	49.9
Propeller	17 P Enertia
Range	102.9 nm
Weight as tested	4,430 lbs

250 HP Mercury 4.5L B3 Sterndrive Data Not Yet Available

This information is provided for comparison purposes and is intended to show relative performance between different boats and engine options. A specific boat's performance will be affected by water and weather conditions, altitude, condition of boat, actual load, engine and propeller. Engine performance data is based on boat in cruise load weight condition. Cruise load weight condition consists of boat with typical options, full tanks, all safety gear, two passengers and typical storage. Cruising range based on cruise speed at cruise load with 10% fuel reserve at rated range.

Features

1. Simple, intuitive controls at the helm
2. Lightweight model for easy storage, trailering and handling
3. Large cockpit with adjustable seating for lounging or entertaining
4. V-Hull allows for a smooth ride with higher speed and improved performance
5. Premium stitched upholstery
6. Molded-in storage and cup holders
7. Award-winning Mercury® engine performance and reliability
8. Filler cushion turns bow into a sun lounge
9. Large sunpad w/integrated headrest
10. Integrated ski locker





DX 2000

 **BAYLINER™**

LENGTH OVERALL (LOA)	19' 7"	5.79 M
WIDTH (BEAM)	8' 1"	2.44 M
MAX PEOPLE CAPACITY	10	9
MAX HORSEPOWER	150 HP	180 HP
DEADRISE	17°	17°
MAX PEOPLE WEIGHT	1,653 LBS	750 KG
FUEL CAPACITY	33 GAL	125 L
DRAFT DOWN	3' 0"	0.91 M
BEAM ON TRAILER	8' 6"	2.6 M

Specification dimensions are approximate and subject to variance.
Colors, graphics and some equipment shown, subject to change without notice.

Standard features

Electrical

- Battery Switch
- Automatic Bilge Pump

Cockpit

- Standard Speakers (4)
- Mooring Cleats (6)
- Cup Holders
- Grab Handles
- Fuel Fill w/ Integrated Vent
- Helm Seat w/ 180° Swivel
- In-Floor Ski/Wakeboard Storage
- Waterproof 120-Watt AM/FM Stereo w/ Bluetooth Capability

Engine

- 115 HP Mercury® FourStroke XL EFI Outboard

Helm

- Multi-Function Gauges w/ Fog Resistant Glass Lenses:
 - Fuel, Speedometer, Tachometer, Voltmeter
- 12V Accessory Outlet
- 12V Horn
- Side-Mounted Engine Controls w/ Trim & Tilt Switch in Handle
- Tilt Steering
- Mechanical Cable Steering (Outboard Models)
- Analog Trim Indicator
- Custom Sport Steering Wheel

Hull & Deck

- Bow & Transom Eyes (3)
- 12V Navigation Lights
- Bow Ladder w/ Hinged Lid
- Anchor Locker
- Fiberglass Floor Liner
- Swim Platform w/ Telescoping Ladder
- Swim Platform Extension
- Aerated Livewell
- V-Hull for Added Performance



Exterior

- Solid White Hull
- Solid Rally Red hull
- Solid Black hull
- Solid Blue hull
- Solid Gray hull
- Solid Reef Green
- Rally Red w/ White bottom
- Black w/ White bottom
- Blue w/ White bottom
- Gray w/ White bottom
- Reef Green w/ White bottom

Interior

- Graphite (Gray)
- Coastline (Tan)
- Gray/White

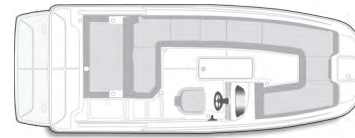

Maximum seating layout (Standard)

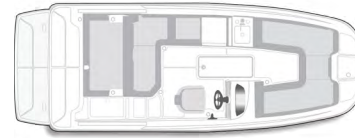

Entertainment layout w/ integrated sink



Dual console layout w/ windshield

Optional add-ons

OB Engines

- 115 HP Mercury® Pro XS XL Outboard
- 150 HP Mercury® FourStroke EFI Outboard
- High Altitude Prop

Steering

- Hydraulic Steering System (115 HP and Below)

Tops

- Bimini, 6' Top w/ Boot ★
- ProArc Tower w/ Integrated Bimini Top
- Tower Speaker Option

Canvas

- Snap-On Bow Well & Cockpit Cover ★
- Snap-On Bow Well & Cockpit Cover (Non-Windshield)

Floor Covering

- Cockpit Flooring (Gray Mat) ★
- Cockpit Flooring (Teak Mat) ★
- Snap-In Seagrass Woven Floor Covering (Teak)
- Snap-In Seagrass Woven Floor Covering (Gray)

Deck Layout

- Maximum Seating Layout
- Entertainment Layout w/ Integrated Sink
- Dual Console Layout w/ Windshield

Seats & Upholstery

- Bow Filler Cushion

Lighting

- Exterior Lighting (LED Docking Lights, 2x Rear Underwater Lights)

Appearance Package

- Stainless Package (Cup Holders, Fuel Fill, Thru Hull, Horn Vent, Bow Hatch, Latches, Rub Rail)
- Hull Sport Graphics

Water Sports

- Ski Tow Pylon
- Wakeboard Rack (1)
- Wakeboard Rack (2)

Swim Platforms

- Swim Platform Mat (Gray)
- Swim Platform Mat (Teak)
- Extended Swim Platform Mat (Gray)
- Extended Swim Platform Mat (Teak)

Convenience Options

- 7" Glass Dash Screen w/ Engine Data
- Wireless Phone Charger
- Bow Table
- Cockpit Table
- Digital Depth Indicator ★
- Portable Head
- Transom Shower w/ On-Demand Water System
- Bow Wind Block (Requires Bow Filler Cushion)
- VesselView® Mobile
- Dual Battery Trays w/Switch
- Rockford Fosgate® System (4 speaker)

Trailer

- Single Axle Painted Trailer w/ Brakes and Swing Tongue
- Single Axle Galvanized Trailer w/ Brakes & Swing Tongue



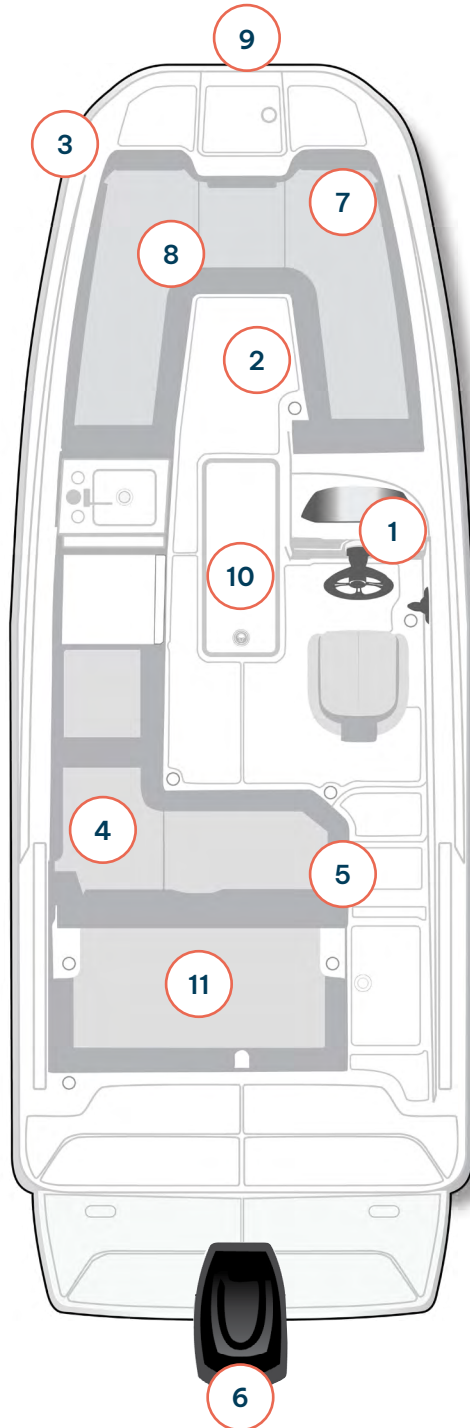

Features

1. Simple and intuitive helm controls
2. Three different layout options available to fit your lifestyle
3. V-Hull allows for a smooth ride with higher speed and less splashing
4. Premium stitched upholstery
5. Molded-in storage and cup holders
6. Award-winning Mercury® engine performance and reliability
7. Filler cushion turns bow into a sun lounger
8. Pontoon style seating
9. Bow entry ladder
10. Ski locker
11. Large sunpad





DX 2050

 **BAYLINER™**

LENGTH OVERALL (LOA)	19' 7"	6 M
WIDTH (BEAM)	8' 1"	2.44 M
MAX PEOPLE CAPACITY	9	8
MAX HORSEPOWER	250 HP	250 HP
DEADRISE	17°	17°
MAX PEOPLE WEIGHT	1,270 LBS	576 KG
FUEL CAPACITY	33 GAL	125 L
DRAFT DOWN	2' 8"	0.81 M
HEIGHT ON TRAILER ¹	7' 1"	2.1 M
BEAM ON TRAILER	8' 6"	2.6 M
STORAGE LENGTH ²	20' 7"	6.27 M

Specification dimensions are approximate and subject to variance.

¹ Tongue jack lowered all the way down.

² Stern drive in down position and trailer tongue swung to side.

Colors, graphics and some equipment shown, subject to change without notice.

Standard Features

Electrical

Battery Switch
Automatic Bilge Pump

Cockpit

Standard Speakers (4)
Cup Holders (6)
Mooring Cleats (6)
Grab Handles
Fuel Fill w/ Integrated Vent
Helm Seat w/ 180° Swivel
In-Floor Ski/Wakeboard Storage
Waterproof 120-Watt AM/FM Stereo
w/ MP3 Capability

Engine

200 HP MerCruiser® ECT 4.5L MPI Sterndrive (Alpha 1 Outdrive)

Helm

Multi-Function Gauges w/ Fog Resistant Glass Lenses:
Fuel, Speedometer, Tachometer, Voltmeter
12V Accessory Outlet
12V Horn
Side-Mounted Engine Controls w/ Trim & Tilt Switch in Handle
Tilt Steering
Analog Trim Indicator
Custom Sport Steering Wheel

Hull & Deck

Bow & Transom Eyes (3)
12V Navigation Lights
Bow Ladder w/ Hinged Lid
Stainless Steel Tow Ring
Fiberglass Floor Liner
Swim Platform w/ Telescoping Ladder
Maximum Seating Layout
V-Hull for Added Performance



Exterior color

- Solid White Hull
- Solid Rally Red hull
- Solid Black hull
- Solid Blue hull
- Solid Gray hull
- Solid Reef Green
- Rally Red w/ White bottom
- Black w/ White bottom
- Blue w/ White bottom
- Gray w/ White bottom
- Reef Green w/ White bottom

Interior color

- Graphite (Gray)
- Coastline (Tan)
- Gray/White

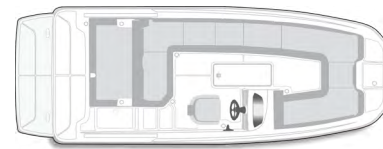

Maximum seating layout (Standard)

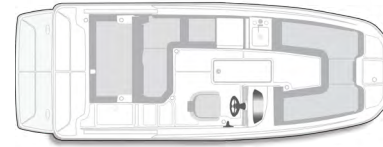

Entertainment layout w/ integrated sink



Dual console layout w/ windshield

Optional add-ons

I/O Engines

- 250 HP Mercruiser 4.5L MPI Sterndrive (Alpha 1 Outdrive) Carb Compliant
- 200 HP Mercruiser 4.5L MPI Sterndrive (Alpha 1 Outdrive) Canada and International Only
- 250 HP Mercruiser 4.5L MPI Sterndrive (Alpha 1 Outdrive 1.81) Canada and International Only

Tops

- Bimini, 6' Top w/ Boot ★
- ProArc Tower w/ Integrated Bimini Top
- Tower Speaker Option

Canvas

- Snap-On Bow Well & Cockpit Cover ★
- Snap-On Bow Well & Cockpit Cover (Non-Windshield)

Floor Covering

- Cockpit Flooring (Gray Mat) ★
- Cockpit Flooring (Teak Mat) ★
- Snap-In Seagrass Woven Floor Covering (Teak)
- Snap-In Seagrass Woven Floor Covering (Gray)

Floor Layout

- Entertainment Layout w/ Integrated Sink
- Dual Console Layout w/ Windshield

Seats & Upholstery

- Bow Filler Cushion

Appearance Package

- Stainless Package
- Hull Sport Graphics

Lighting

- Exterior Lighting (LED Docking Lights, 2x Rear Underwater Lights)

Water Sports

- Wakeboard Rack (1)
- Wakeboard Rack (2)

Swim Platforms

- Swim Platform Mat (Gray)
- Swim Platform Mat (Teak)
- Extended Swim Platform Mat (Gray)
- Extended Swim Platform Mat (Teak)
- Swim Platform Extension
- Swim Platform Extension/Color Match/Teak
- Swim Platform Extension/Color Match/Gray

Convenience Options

- Rockford Fosgate® System (4 speaker)
- 7" Glass Dash Screen w/ Engine Data
- Bow Table
- Cockpit Table
- Digital Depth Indicator ★
- High Altitude Prop
- Portable Head
- Transom Shower w/ On-Demand Water System
- Bow Wind Block (Requires Bow Filler Cushion)
- VesselView® Mobile
- Dual Battery Trays w/Switch
- Wireless Phone Charger

Trailer

- Single Axle Galvanized Trailer w/ Brakes & Swing Tongue
- Single Axle Painted Trailer w/ Brakes and Swing Tongue (Black)



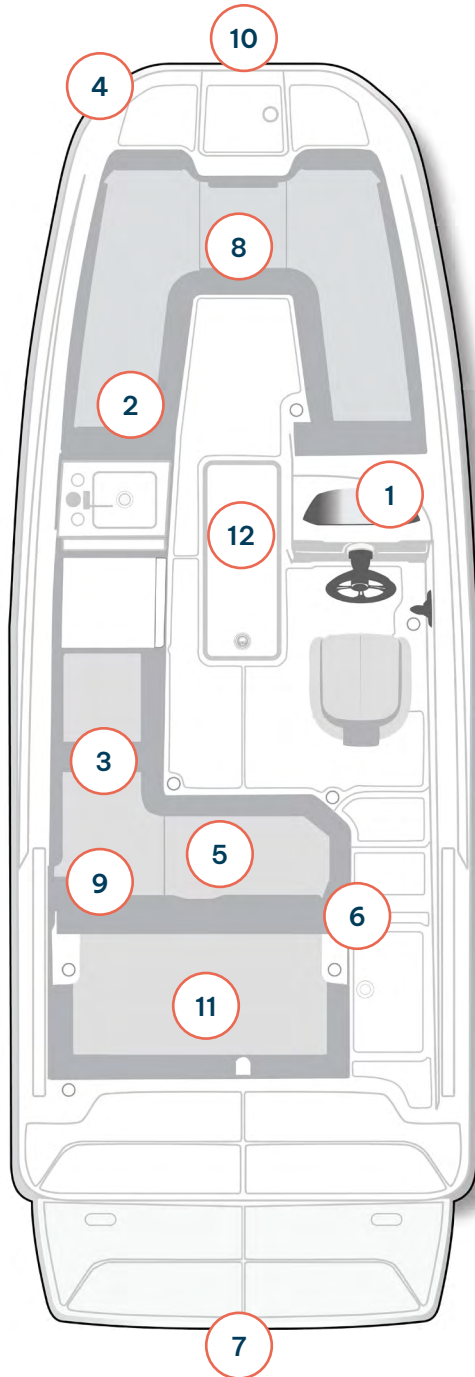

Features

1. Simple and intuitive helm controls
2. Lightweight model for easy storage, trailering and handling
3. Three different layout options available to fit your lifestyle
4. V-Hull allows for a smooth ride with higher speed and less splashing
5. Premium stitched upholstery
6. Molded-in storage and cup holders
7. Award-winning Mercury® engine performance and reliability
8. Filler cushion turns bow into a sun lounger
9. Pontoon style seating
10. Bow entry ladder
11. Large sunpad
12. Ski locker





DX 2200

 **BAYLINER™**

LENGTH OVERALL (LOA)	21' 7"	6.57 M
WIDTH (BEAM)	8' 6"	2.6 M
MAX PEOPLE CAPACITY	12	9
MAX HORSEPOWER	200 HP	250 HP
DEADRISE	20°	20°
MAX PEOPLE WEIGHT	1,692 LBS	767 KG
FUEL CAPACITY	55 GAL	208 L
DRAFT DOWN	2' 9"	0.8 M
BEAM ON TRAILER	8' 6"	2.4 M

Specification dimensions are approximate and subject to variance.
Colors, graphics and some equipment shown, subject to change without notice.

Standard features

Electrical

Battery Switch
Automatic Bilge Pump

Cockpit

Standard Speakers (4)
Cup Holders (8)
Mooring Cleats (6)
Grab Handles
Fuel Fill w/ Integrated Vent
Helm Seat w/ 180° Swivel
In-Floor Ski/Wakeboard Storage
Waterproof 120-Watt AM/FM Stereo
w/ Bluetooth Capability

Engine

150 HP EFI 4 Stroke, Mercury® Outboard

Helm

Multi-Function Gauges w/ Fog Resistant Glass Lenses:
Fuel, Speedometer, Tachometer, Voltmeter
12V Accessory Outlet
12V Horn
Side-Mounted Engine Controls w/ Trim & Tilt Switch in Handle
Tilt Steering
Analog Trim Indicator
Custom Sport Steering Wheel

Hull & Deck

Bow & Transom Eyes (3)
12V Navigation Lights
Bow Ladder w/ Hinged Lid
Stainless Steel Tow Ring
Anchor Locker
Fiberglass Floor Liner
Swim Platform w/ Telescoping Ladder
Swim Platform Extension
V-hull for Added Performance
Wet Bar



Exterior color

- Solid White Hull
- Solid Rally Red hull
- Solid Black hull
- Solid Blue hull
- Solid Gray hull
- Solid Reef Green
- Rally Red w/ White bottom
- Black w/ White bottom
- Blue w/ White bottom
- Gray w/ White bottom
- Reef Green w/ White bottom

Interior color

- Graphite (Gray)
- Coastline (Tan)
- Gray/White

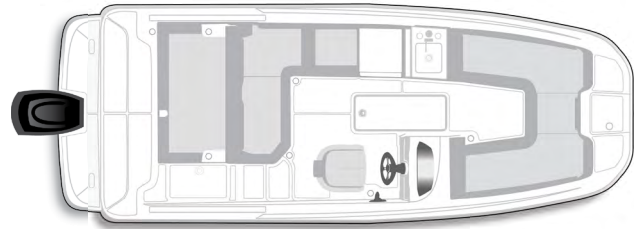

Optional add-ons

OB Engines

- 200 HP Black Mercury® Fourstroke OB Non-DTS
- Power Steering 175 HP and Higher-OB only
- Pre-rig, Blank V6 Mercury DTS
- Pre-rig, Blank V8 Mercury DTS

Tops

- Bimini, 6' Top w/ Boot ★
- ProArc Tower w/ Integrated Bimini Top

Canvas

- Snap-On Bow Well & Cockpit Cover ★
- Snap-On Bow Well & Cockpit Cover (Non-Windshield)

Floor Covering

- Cockpit Flooring (Gray Mat) ★
- Cockpit Flooring (Tan Mat) ★
- Snap-In Seagrass Woven Floor Covering (Tan)
- Snap-In Seagrass Woven Floor Covering (Gray)

Seats & Upholstery

- Bow Filler Cushion

Appearance Package

- Stainless Package
- Hull Sport Graphics

Lighting

- Exterior Lighting (LED Docking Lights, 2x Rear Underwater Lights)

Water Sports

- Ski Tow Pylon
- Wakeboard Rack (1)
- Wakeboard Rack (2)

Swim Platforms

- Swim Platform Mat (Gray)
- Swim Platform Mat (Teak)
- Extended Swim Platform Mat (Gray)
- Extended Swim Platform Mat (Teak)

Convenience Options

- 7" Glass Dash Screen w/ Engine Data
- Wireless Phone Charger
- Bow Table
- Cockpit Table
- Digital Depth Indicator ★
- High Altitude Prop
- Portable Head
- Transom Shower w/ On-Demand Water System
- Bow Wind Block (Requires Bow Filler Cushion)
- VesselView® Mobile
- Refrigerator
- Rockford Fosgate® System (4 speaker)
- Dual Battery Trays w/Switch
- Tower Speaker Option (2)
- Full Windshield w/ Opening Center Panel

Fishing Accessories

- Aerated Livewell
- Bow Casting Platform & Seat
- Dual Battery w/ 24V Plug
- Fish Finder: Lowrance®
- Trolling Motor Bracket w/ 24V Plug

Trailer

- Tandem Axle Galvanized Trailer w/ Brakes
- Tandem Axle Painted Trailer w/ Brakes

★ Popular option

* CANADA AND INTERNATIONAL ONLY



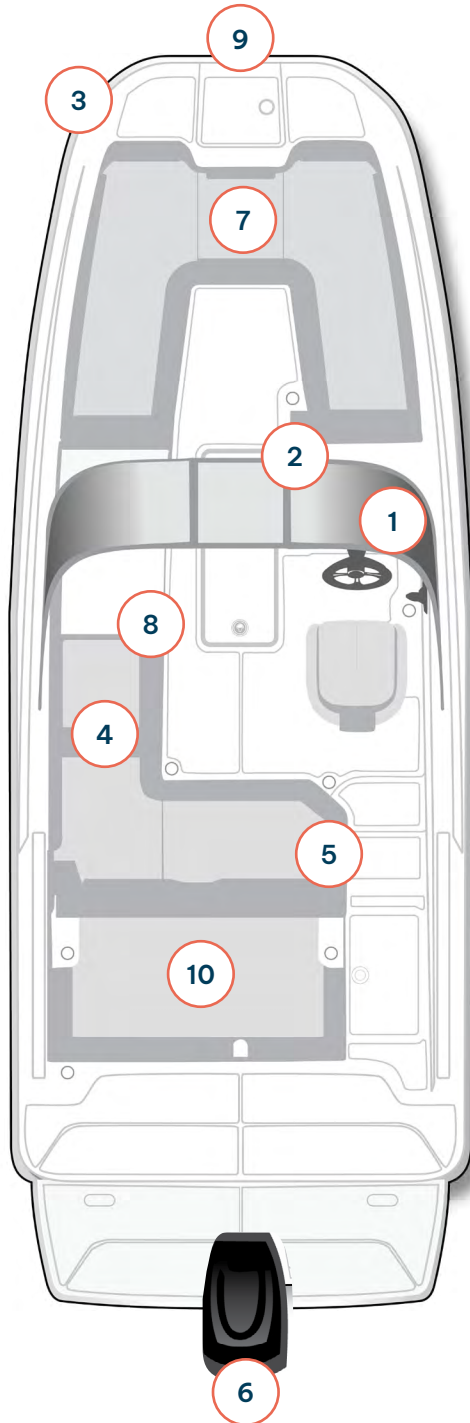

Features

1. Simple and intuitive helm controls
2. Two different layouts to fit your lifestyle
3. V-Hull allows for a smooth ride with higher speed and less splashing
4. Premium stitched upholstery
5. Molded-in storage and cup holders
6. Award-winning Mercury® engine performance and reliability
7. Filler cushion turns bow into a sun lounger
8. Pontoon style seating
9. Bow entry ladder
10. Large sunpad





DX 2250

 **BAYLINER™**

LENGTH OVERALL (LOA)	21' 7"	6.57 M
WIDTH (BEAM)	8' 4"	2.6 M
MAX PEOPLE CAPACITY	11	9
MAX HORSEPOWER	250 HP	250 HP
DEADRISE	20°	20°
MAX PEOPLE WEIGHT	1,552 LBS	704 KG
FUEL CAPACITY	55 GAL	208 L
DRAFT DOWN	2' 9"	0.83 M
BEAM ON TRAILER	8' 6"	2.6 M

Specification dimensions are approximate and subject to variance.
Colors, graphics and some equipment shown, subject to change without notice.

Standard features

Electrical

Battery Switch
Automatic Bilge Pump

Cockpit

Standard Speakers (4)
Cup Holders (4)
Mooring Cleats (6)
Grab Handles (8)
Fuel Fill w/ Integrated Vent
Helm Seat w/ 180 Degree Swivel
In-Floor Ski/Wakeboard Storage
Waterproof 120-Watt AM/FM Stereo
w/ Bluetooth Capability

Engine

200 HP MerCruiser® ECT 4.5L MPI Sterndrive (Alpha 1 Outdrive)

Helm

Multi-Function Gauges w/ Fog Resistant Glass Lenses: Fuel,
Speedometer, Tachometer, Voltmeter
12V Accessory Outlet
12V Horn
Side-Mounted Engine Controls w/ Trim & Tilt Switch in Handle
Tilt Steering
Custom Sport Steering Wheel
Analog Trim Indicator

Hull & Deck

Bow & Transom Eyes (3)
12V Navigation Lights
Bow Ladder w/ Hinged Lid
Fiberglass Floor Liner
Swim Platform w/ Telescoping Ladder
V-Hull for Added Performance
Wet Bar



DX2250



Exterior color

- Solid White Hull
- Solid Rally Red hull
- Solid Black hull
- Solid Blue hull
- Solid Gray hull
- Solid Reef Green
- Rally Red w/ White bottom
- Black w/ White bottom
- Blue w/ White bottom
- Gray w/ White bottom
- Reef Green w/ White bottom

Interior color

- Graphite (Gray)
- Coastline (Tan)
- Gray/White

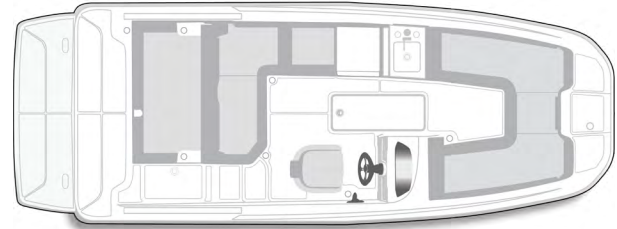

Optional add-ons

I/O Engines

- 200 HP MerCruiser® 4.5L MPI Sterndrive (Alpha 1 Outdrive)*
- 250 HP MerCruiser® ECT 4.5L MPI Sterndrive (Alpha 1 Outdrive)
- 250 HP MerCruiser® 4.5L MPI Sterndrive (Alpha 1 Outdrive)*
- High Altitude Prop

Tops

- Bimini, 6' Top w/ Boot ★
- ProArc Tower w/ Integrated Bimini Top
- Tower Speaker Option

Windshield

- Windshield w/ Opening Center Panel & Side Wings

Canvas

- Snap-On Bow Well & Cockpit Cover ★
- Snap-On Bow Well & Cockpit Cover (Non-Windshield)

Floor Covering

- Cockpit Flooring (Gray Mat) ★
- Cockpit Flooring (Teak Mat) ★
- Snap-In Seagrass Woven Floor Covering (Teak)
- Snap-In Seagrass Woven Floor Covering (Gray)

Seats & Upholstery

- Bow Filler Cushion

Appearance Package

- Stainless Package
- Hull Sport Graphics

Lighting

- Exterior Lighting (LED Docking Lights, 2x Rear Underwater Lights)

Water Sports

- Wakeboard Rack (1)
- Wakeboard Rack (2)

Swim Platforms

- Swim Platform Mat (Gray)
- Swim Platform Mat (Teak)
- Extended Swim Platform Mat (Gray)
- Extended Swim Platform Mat (Teak)
- Swim Platform Extension
- Swim Platform Extension/Color Match/Teak
- Swim Platform Extension/Color Match/Gray

Convenience Options

- 7" Glass Dash Screen w/ Engine Data
- Wireless Phone Charger
- Bow Table
- Cockpit Refrigerator (12V)
- Cockpit Table
- Digital Depth Indicator ★
- Portable Head
- Transom Shower w/ On-Demand Water System
- Bow Wind Block (Requires Bow Filler Cushion)
- VesselView® Mobile
- Rockford Fosgate® System (4 speaker)
- Dual Battery Trays w/Switch
- High Altitude Prop

Fishing Accessories

- Bow Casting Platform & Seat
- Dual Battery w/ 24V Plug
- Fish Finder: Lowrance®
- Trolling Motor Bracket w/ 24V Plug
- Aerated Livewell

Trailer

- Tandem Axle Painted Trailer w/Brakes
- Tandem Axle Galvanized Trailer w/Brakes

★ Popular option

* CANADA AND INTERNATIONAL ONLY



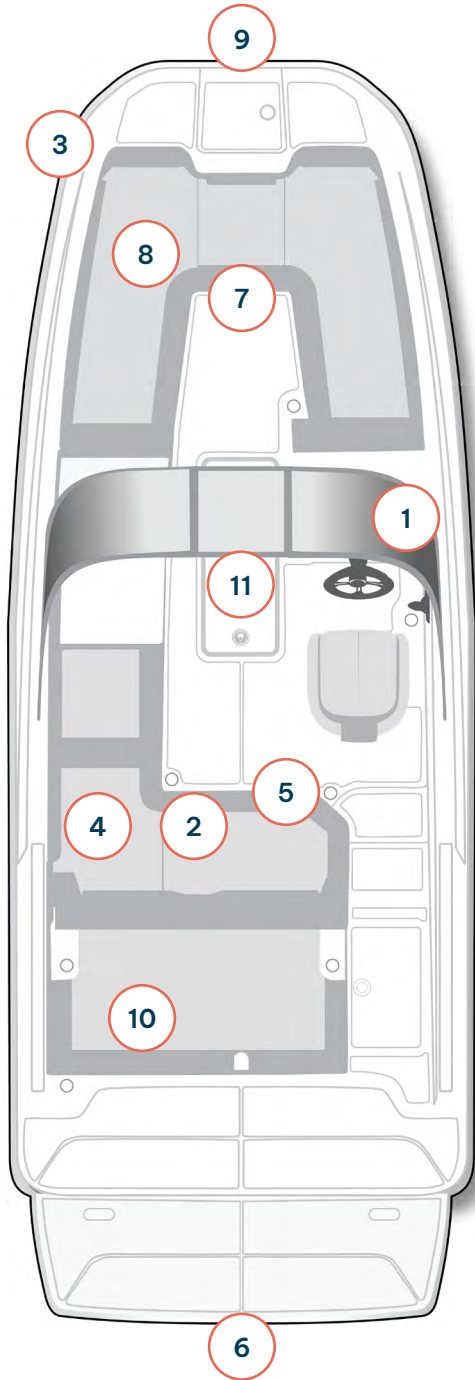

Features

1. Simple and intuitive helm controls
2. Two different layouts to fit your lifestyle
3. V-Hull allows for a smooth ride with higher speed and less splashing
4. Premium stitched upholstery
5. Molded-in storage and cup holder
6. Award-winning Mercury® engine performance and reliability
7. Filler cushion turns bow into a sun lounger
8. Pontoon style seating
9. Bow entry ladder
10. Large sunpad
11. Ski locker





T18 Bay

 **BAYLINER**

LENGTH OVERALL (LOA)	18' 2"	5.5 M
WIDTH (BEAM)	7' 5"	2.3 M
MAX PEOPLE CAPACITY	6	6
MAX HORSEPOWER	115 HP	115 HP
DEADRISE	17°	17°
MAX PEOPLE WEIGHT	992 LBS	424 KG
FUEL CAPACITY	33 GAL	125 L
DRAFT DOWN	2' 7"	0.79 M
BEAM ON TRAILER	8' 6"	2.6 M

Specification dimensions are approximate and subject to variance.
Colors, graphics and some equipment shown, subject to change without notice.

Standard features

Electrical

- Battery Switch
- Automatic Bilge Pump
- Dual Battery w/ 24V Plug

Cockpit

- Cup Holders
- Mooring Cleats (6)
- Grab Handles
- Fuel Fill w/ Integrated Vent
- Flip-Flop Cooler Seat
- Self-Bailing Cockpit

Engine

- 90 HP Mercury® FourStroke XL EFI Outboard

Helm

- Dual Purpose Gauge: Speedometer, Voltmeter
- 12V Accessory Outlet
- 12V Horn
- Binnacle-Mounted Engine Controls w/ Trim & Tilt Switch in Handle
- Center Console w/ Stainless Steel Steering Wheel
- Mechanical Cable Steering
- Analog Trim Indicator

Hull & Deck

- Bow & Transom Eyes (3)
- 12V Navigation Lights
- M-Hull Design for Added Stability
- Fiberglass Floor Liner
- Helm Windscreen
- Integrated trolling motor mount

Trailer

- Single Axle Galv Trailer



T18Bay



Exterior color

- Solid White Hull
- Solid Black hull
- Solid Gray hull
- Solid Blue hull
- Solid Reef Green hull
- White bottom w/ Black hull
- White bottom w/ Gray hull
- White bottom w/ Blue hull
- White bottom w/ Reef Green hull

Interior color

- White

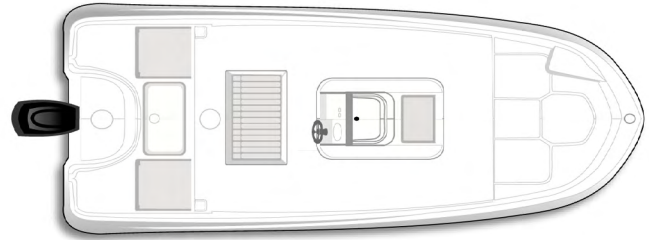

Optional add-ons

Engines

- 115 HP Mercury® FourStroke Command Thrust EFI Outboard
- 115 HP Mercury® FourStroke XL EFI Outboard
- 115 HP Mercury® Pro XS XL Outboard
- High Altitude Prop

Steering

- Hydraulic Steering System (115 HP and Below)

Tops

- K-Top
- T-Top w/ Rail-Mounted Rod Holders (4)
- Bimini, 6' Top w/ Boot ★

Canvas

- Snap-On Center Console & Helm Seat Cover ★
- Console Cover

Seats & Upholstery

- Bow Filler Cushion

Appearance Package

- Stainless Steel Package
- Trophy Logo Decal 8" Tall (in lieu of Standard)

Lighting Package

- Interior Lighting Package

Water Sports

- Wakeboard Rack (1x)
- Wakeboard Rack (2x)

Swim Platforms

- Port and Starboard Swim Boards w/ Ladder

Convenience Options

- 7" Glass Dash Screen w/ Engine Data
- Extra Wide Console
- Analog Trim Indicator
- Bow Rail
- Compass
- Digital Depth Indicator ★
- VesselView® Mobile
- Blank Dash Option
- Waterproof AM/FM Stereo w/ Bluetooth
- VHF Radio w/ Antenna

Fishing Accessories

- Bow Fishing Seat
- Fish Finder: Lowrance®
- Forward Livewell
- Trolling Motor Bracket

★ Popular option



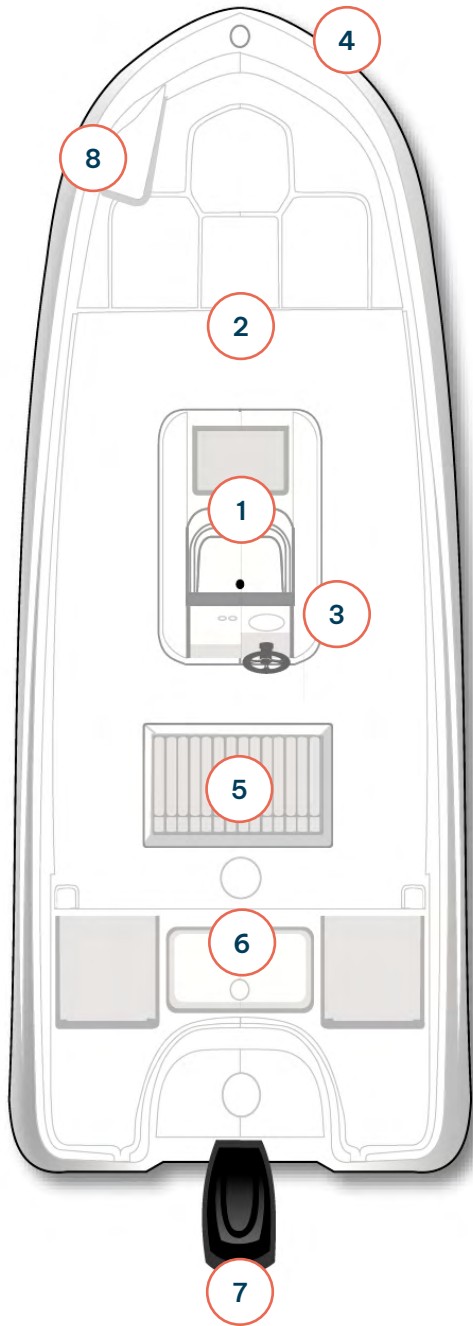

Features

1. Simple and intuitive helm controls
2. Lightweight model for easy storage, trailering and handling
3. Center Console design for all around casting ease
4. M-Hull design allows for more lateral stability when casting and shallower draft for getting in close
5. Premium stitched upholstery
6. Baitwell/Livewell
7. Award-winning Mercury® engine performance and reliability
8. Large forward casting platform with molded in trolling motor bracket





Trophy T20

 **BAYLINER™**

LENGTH OVERALL (LOA)	20' 6"	6.10 M
WIDTH (BEAM)	8' 0"	2.43 M
MAX PEOPLE CAPACITY	8	7
MAX HORSEPOWER	175 HP	200 HP
DEADRISE	18°	18°
MAX PEOPLE WEIGHT	1,323 LBS	600 KG
FUEL CAPACITY	55 GAL	208 L
DRAFT DOWN	2' 8"	0.61 M
HEIGHT ON TRAILER W/ OPTIONS	8' 11"	2.71 M
BRIDGE CLEARANCE W/ OPTIONS	7' 2"	2.19 M
BEAM	8' 0"	2.43 M
BEAM ON TRAILER	8' 6"	2.6 M
STORAGE LENGTH ¹	22' 2"	6.76 M

Specification dimensions are approximate and subject to variance.

¹ With trailer/tongue folded

Colors, graphics and some equipment shown, subject to change without notice.

Standard features

Cockpit

Self-Bailing Cockpit
Fuel Fill w/ Integrated Vent
Waterproof 120-Watt AM/FM Stereo
w/ Bluetooth Capability
Leaning Post
Battery Switch
Automatic Bilge Pump
Removable Cushions
CC Package - Flip-Up Transom Seats

Fishing

Center Console w/ Stainless Steel Steering Wheel
Leaning Post Livewell
Insulated Fish Box
Transom Aerated Livewell - CC Seating Pkg Only

Trailer

Tandem Axle Black Painted or
Galvanized Trailer w/Brakes

Engine

115 HP Mercury® FourStroke EFI Outboard

Helm

Multi-Function Gauges w/ Fog Resistant Glass Lenses: Fuel, Speedometer,
Tachometer, Voltmeter
12V Horn
Binnacle-Mounted Engine Controls w/ Trim & Tilt Switch in Handle
Tilt Steering
Mechanical Throttle and Shift

Steering

Hydraulic Steering System

Hull & Deck

Bow & Transom Eyes (3)
12V Navigation Lights
Anchor Locker
Fiberglass Floor Liner
Gunnel Rod Holders (4)
Helm Windscreen
Port and Starboard Swim Boards w/ Ladder



T20 CC/CX

BAYLINER™

Exterior color

- Solid White Hull
- Solid Black hull
- Solid Gray hull
- Solid Blue hull
- Solid Reef Green hull
- White bottom w Black hull
- White bottom w Gray hull
- White bottom w Blue hull
- White bottom w Reef Green hull

Interior color

- Graphite (Gray)
- Coastline (Tan)

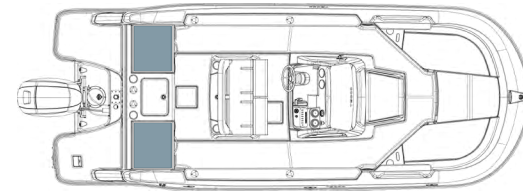

CC
Flip-Up Transom Seats

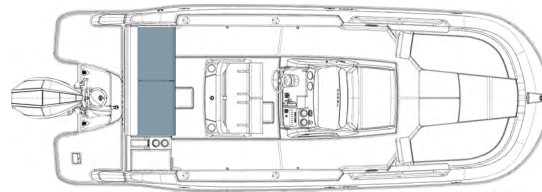

CX
Transom Cruising Bench Seat

Optional add-ons

Engines

- 115 HP 4-Stroke EFI Command Thrust Mercury® Outboard
- 115 HP Mercury® Pro XS XL Outboard
- 150 HP Mercury® FourStroke EFI Outboard
- 175 HP Mercury® Fourstroke ProXS Outboard
- Pre-Rig, Blank V6 Mercury DTS
- Blank, Mercury Outboard 135HP and Higher
- High Altitude Prop

Steering

- Power Steering – 175 HP and higher, OB

Tops

- T-Top w/ Rail-Mounted Rod Holders (4)
- Bimini, 6' Top w/ Boot ★

Canvas

- Snap-On Center Console & Helm Seat Cover ★

Floor Covering

- Cockpit Flooring (Gray Mat) ★
- Cockpit Flooring (Teak Mat) ★

Seats & Upholstery

- CC Package - Flip-Up Transom Seats
- CX Package - Transom Cruising Bench Seat
- Bow Filler Cushion

Fishing Accessories

- Dual Battery Trays w/ 24V Plug

Appearance Package

- Stainless Package (Fuel Fill, Thru Hull, Horn Vent, Bow Hatch, Latches, Rub Rail)
- Large Trophy Decal Set

Lighting

- Exterior Lighting (LED Docking Lights, 2x Rear Underwater Lights)
- Interior Lighting

Water Sports

- Ski Tow Pylon

Convenience Options

- 7" Glass Dash Screen w/ Engine Data*
- 9" Glass Dash Screen w/ Engine Data*
- Twin Simrad 7" Digital Dashes with VesselView® Link
- Twin Simrad 9" Digital Dashes with VesselView® Link
- Transom Shower w/ On-Demand Water System
- Cockpit Table
- Digital Depth Indicator ★
- VesselView® Mobile
- Rockford Fosgate® Stereo System
- Anchor Roller
- Dual Battery Trays w/ Switch
- Raw Water Washdown

★ Popular option

* Glass Dash options available in dual screen configurations



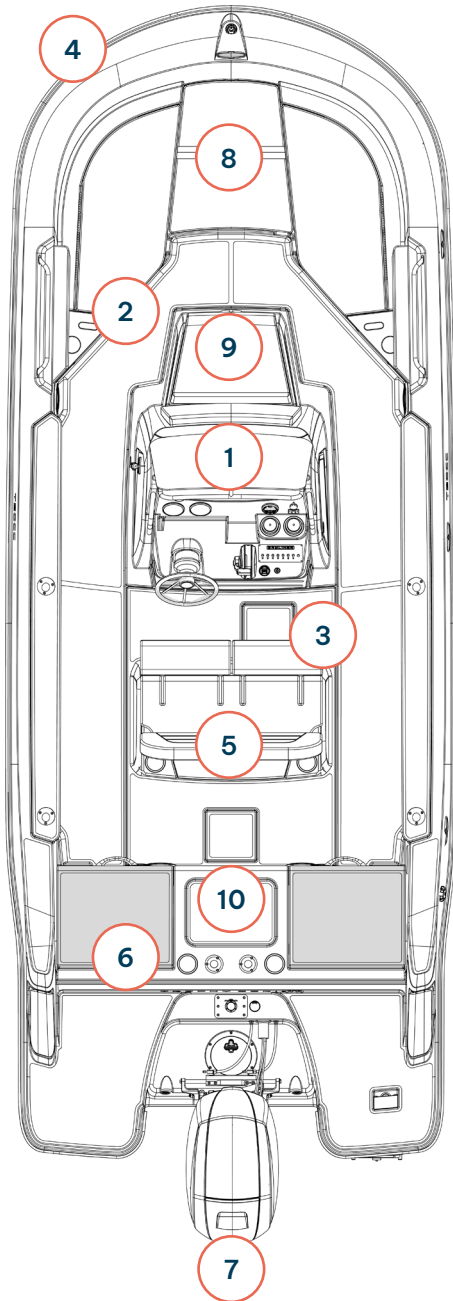

Features

1. Simple and intuitive helm controls
2. Lightweight model for easy storage, trailering and handling
3. Center console design for all around casting ease
4. V-Hull allows for a smooth ride with higher speed and a dryer ride
5. Premium stitched upholstery
6. Molded-in storage and cup holders
7. Award-winning Mercury® engine performance and reliability
8. Filler cushion turns bow into a sun lounger
9. Built-in forward console storage
10. Integrated livewell/baitwell (CC Package only)





Trophy T22

 **BAYLINER™**

LENGTH OVERALL (LOA)	22' 7"	6.88 M
WIDTH (BEAM)	8' 6"	2.6 M
MAX PEOPLE CAPACITY	10	8
MAX HORSEPOWER	300 HP	300 HP
DEADRISE	18°	18°
MAX PEOPLE WEIGHT	1,654 LBS	750 KG
FUEL CAPACITY	65 GAL	246 L
DRAFT DOWN	3' 1"	0.93 M
BEAM ON TRAILER	8' 6"	2.6 M

Specification dimensions are approximate and subject to variance.

¹ Tongue jack lowered all the way down.

² Stern drive in down position and trailer tongue swung to side.

Colors, graphics and some equipment shown, subject to change without notice.

Standard features

Electrical

Battery switch
Automatic Bilge Pump

Cockpit

Self-Bailing Cockpit
Fuel Fill w/ Integrated Vent
Waterproof 120-Watt AM/FM Stereo w/
Bluetooth Capability
Leaning Post
Removable Cushions
CC Package - Flip-Up Transom Seats

Fishing

Center Console w/ Stainless Steel Steering
Wheel
Leaning Post w/ Livewell
Aerated Livewell, CC
Insulated Fish Box

Engine

150 HP Mercury® FourStroke EFI Outboard

Helm

Multi-Function Gauges w/ Fog Resistant Glass Lenses: Fuel, Speedometer,
Tachometer, Voltmeter
12V Horn
Binnacle-Mounted Engine Controls w/ Trim & Tilt Switch in Handle
Tilt Steering
Mechanical Throttle and Shift

Hull & Deck

Bow & Transom Eyes (3)
12V Navigation Lights
Anchor Locker
Fiberglass Floor Liner
Gunnel Rod Holders (4)
Helm Windscreen
Port and Starboard Swim Boards w/ Ladder

Trailer

Tandem Axle Painted or Galvanized Trailer w/Brakes



T22 CC/CX

BAYLINER™

Exterior color

- Solid White Hull
- Solid Black hull
- Solid Gray hull
- Solid Blue hull
- Solid Reef Green hull
- White bottom w/ Black hull
- White bottom w/ Gray hull
- White bottom w/ Blue hull
- White bottom w/ Reef Green hull

Interior color

- Graphite (Gray)
- Coastline (Tan)

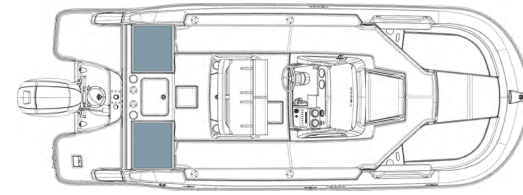

CC
Flip-Up Transom Seats

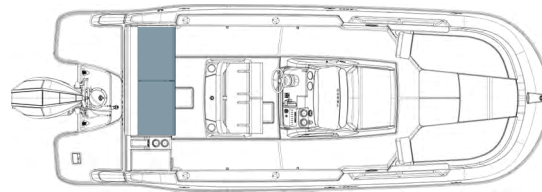

CX
Transom Cruising Bench Seat

Optional add-ons

OB Engines

- 175 HP Mercury® Fourstroke ProXS Outboard
- 200 HP Mercury® FourStroke Outboard Non-DTS (Black)
- 250 HP Black Mercury® OB Non-DTS (Black)
- 300 HP Black Mercury® Verado® OB
- High Altitude Prop
- Pre-rig for V6 Mercury® DTS
- Pre-rig, Blank V8 Mercury® DTS
- Warm Fusion White Options Available as Applicable

Steering

- Power Steering – 175 HP and higher

Tops

- T-Top w/ Rail-Mounted Rod Holders (4)
- Bimini, 6' Top w/ Boot ★

Canvas

- Snap-On Center Console & Helm Seat Cover ★

Floor Covering

- Cockpit Flooring (Gray Mat) ★
- Cockpit Flooring (Teak Mat) ★

Seats & Upholstery

- CC Package - Flip-Up Transom Seats
- CX Package - Transom Cruising Bench Seat
- Bow Filler Cushion

Fishing Accessories

- Dual Battery Trays w/ 24V Plug

Appearance Package

- Stainless Package (Fuel Fill, Thru Hull, Horn Vent, Bow Hatch, Latches, Rub Rail)
- Large Trophy Decal Set

Lighting Package

- Exterior Lighting (LED Docking Lights, 2x Rear Underwater Lights)
- Interior Lighting Package

Water Sports

- Ski Tow Pylon

Convenience Options

- 7" Glass Dash Screen w/ Engine Data*
- 9" Glass Dash Screen w/ Engine Data*
- Twin Simrad 7" Digital Dashes with VesselView® Link
- Twin Simrad 9" Digital Dashes with VesselView® Link
- Transom Shower w/ On-Demand Water System
- Bilge Pump (Automatic) ★
- Cockpit Table
- Digital Depth Indicator ★
- Portable Head
- VesselView® Mobile
- Raw Water Washdown
- Anchor Roller
- Dual Battery Trays w/ Switch
- Rockford Fosgate® Stereo Upgrade
- Leaning Post

★ Popular option

* Glass Dash options available in dual screen configurations



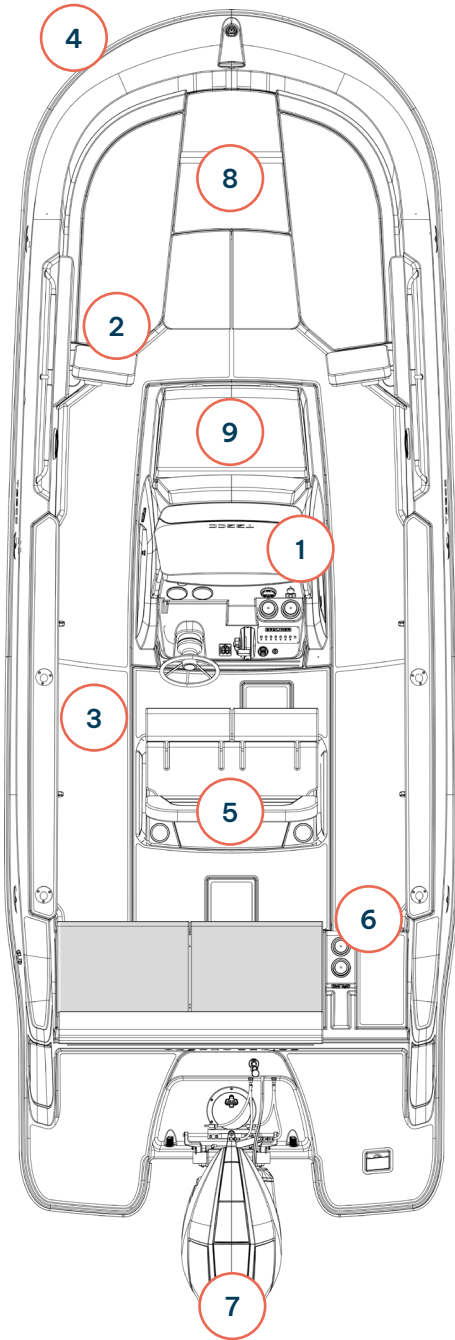

Features

1. Simple and intuitive helm controls
2. Lightweight model for easy storage, trailering and handling
3. Center console design for all around fishing ease
4. V-Hull allows for a smooth ride with higher speed and near shore performance
5. Premium stitched upholstery
6. Molded-in storage and cup holders
7. Award-winning Mercury® engine performance and reliability
8. Filler cushion turns bow into a sun lounger
9. Built-in forward console storage





Trophy T24CC

 **BAYLINER™**

LENGTH OVERALL (LOA)	24' 7"	7.49 M
WIDTH (BEAM)	8' 6"	2.6 M
MAX PEOPLE CAPACITY	12	12
MAX HORSEPOWER	300 HP	300 HP
DEADRISE	22°	22°
APPROX WEIGHT W/ STANDARD ENGINE	4,466 LBS	2,026 KG
APPROX WEIGHT W/ TRAILER	6,115 LBS	2,774 KG
MAX PEOPLE WEIGHT	1,984 LBS	900 KG
FUEL CAPACITY	100 GAL	378.5 L
DRAFT DOWN	2' 11"	0.89 M
STORAGE HEIGHT¹	11' 2"	3.4 M
BEAM ON TRAILER	8' 6"	2.6 M
STORAGE LENGTH²	32' 10"	10.0 M

Specification dimensions are approximate and subject to variance.

¹ With trailer/tower folded

² Outboard motor in down position and trailer tongue swung to side.

Colors, graphics and some equipment shown, subject to change without notice.

Standard features

Steering

Hydraulic Steering System

Cockpit

Self-Bailing Cockpit
Raw Water Washdown
Fuel Fill w/ Integrated Vent
Waterproof 120-Watt AM/FM Stereo
w/ Bluetooth® Capability
Leaning Post w/ Livewell
Dual Batteries w/ Switch
Automatic Bilge Pump
Removable Bow Backrests and Cushions
Fold-Away Rear Bench Seat
Canvas T-Top w/ Rod Holders (4)
CC Fishing Seats w/ Livewell

Fishing

Center Console w/ Stainless Steel Steering Wheel
15-Gal Baitwell
21-Gal Leaning Post Livewell
6-Ft Dual Insulated Fish Boxes
Under Gunnel Rod Storage
Gunnel Rod Holders (4)

Engine

225 XXL Fourstroke OB Non-DTS (Black)

Helm

Multi-Function Gauges w/ Fog-Resistant Glass Lenses: Fuel,
Speedometer, Tachometer, Voltmeter
12V Horn
Binnacle-Mounted Engine Controls w/ Trim & Tilt Switch in Handle
Tilt Steering
Mechanical Throttle & Shift

Hull & Deck

Bow & Transom Eyes (3)
12V Navigation Lights
Anchor Locker
Fiberglass Floor Liner
Helm Windscreen
Port and Starboard Swim Boards w/ Ladder
Stainless Steel Cleats (6)
Trim Tabs



T24CC

BAYLINER

Exterior color

- Solid White Hull
- Solid Black hull
- Solid Gray hull
- Solid Blue hull
- Solid Reef Green hull
- White bottom w/ Black hull
- White bottom w/ Gray hull
- White bottom w/ Blue hull
- White bottom w/ Reef Green hull

Interior color

- Graphite (Gray)
- Coastline (Tan)



Optional add-ons

OB Engines

- 250 HP XXL Mercury® FourStroke Outboard Non-DTS
- 300 HP XXL Mercury® V8 AMS Outboard (Includes Power-Assisted Steering)
- High Altitude Prop
- Pre-Rig Blank V6 Mercury® DTS
- Pre-Rig Blank V8 Mercury® DTS For 250 HP
- Pre-Rig Blank V8 Mercury® DTS For 300 HP
- Warm Fusion White Options Available as Applicable

Steering

- Power Steering – 175 HP & Higher (Outboard Only)
- Power Steering – 300 HP AMS
- Premium Steering Wheel w/ Knob ★

Tops

- Fiberglass Hardtop w/ Spreader Lights

Canvas

- Snap-On Center Console & Helm Seat Cover ★

Floor Covering

- Cockpit Flooring (Gray Mat) ★
- Cockpit Flooring (Teak Mat) ★

Seats & Upholstery

- Bow Filler Cushion
- Premium Leaning Post w/ Bolsters (Premium Helm Seat w/ Fold up Bolsters, Integrated Livewell And Clear Acrylic Livewell Lid)
- Leaning Post (Base Leaning Post minus Livewell and Seat Bolsters)

Fishing Accessories

- Trolling Motor Bracket w/ 24V Plug
- Trolling Motor Pre-Rig w/ 24V Plug

Water Sport

- Ski Tow Pylon

Appearance Package

- Stainless Package (Fuel Fill, Thru Hull, Horn Vent, Bow Hatch, Latches, Rub Rail) ★
- Large Trophy Decal Set
- 6" Forward, Mid & Aft Pop Up Cleats

Lighting

- Exterior Lighting (LED Docking Lights, 2x Rear Underwater Lights)
- Interior Lighting

Convenience Options

- Simrad 9" Digital Dash* with VesselView® Link
- Twin Simrad 9" Digital Dashes with VesselView® Link
- Cockpit Table
- Digital Depth Indicator ★
- Portable Head
- Freshwater Shower (10-Gal Tank)
- VesselView® Mobile
- Anchor Roller
- Windlass
- Dual Battery Trays w/ Switch ★
- 25-qt Carry-On Cooler
- Rockford Fosgate® System (4 Speaker)
- VHF Radio w/ Antenna
- Blank Dash Option
- CX Package – Transom Cruising Bench Seat
- SmartCraft SC1000 Gauge (Speed & Tach)
- Dual Fishwell Macerator Pumps

Trailer

- Tandem Axle Aluminum Trailer w/ Brakes & Swing Tongue

★ Popular option

* 9" Digital Dash Available in Twin Configuration





Features

1. Simple and intuitive helm controls w/ molded in cupholders and chuck storage
2. Center console design for ease of casting and fishing
3. Deep V-Hull allows for a smooth and dry ride in deeper waters
4. Premium stitched upholstery
5. Molded-in storage and cup holders
6. Award-winning Mercury® engine performance and reliability
7. Filler cushion turns bow into a sun lounger
8. Built-in livewell in standard CC configuration
9. Large in-floor fish lockers
10. Built-in forward console storage





BAYLINER.COM   