



 BAYLINER™

Product Information Guide

CUSTOMER SUCCESS AND SALES SUPPORT

Table of contents

Contacts & Digital Assets	3
Brand	4
Parts and Accessories	8

Bowriders

M15	9
M17	12
M19	15
VR 4, I/O and OB	18
VR 5, I/O and OB	21
VR 6, I/O and OB	24

Deck boats

D20, OB	27
D20I, I/O	30
D22, OB	33
D22I, I/O	36

Center consoles

T18 Bay	39
Trophy 20 CC/CX	42
Trophy 22 CC/CX	45
Trophy 24CC	48

Side console

Trophy 22 SC	51
---------------------------	-----------

Overnight

Trophy 23 Explorer	54
Trophy 25 Explorer	56
Trophy 29 Explorer	58
Trophy 23 Pilothouse	60
Trophy 25 Pilothouse	62

Who to contact

Warranty

For warranty inquiries, claims, ownership/registration, labor rate affidavits & inquiries, please email warranty@bayliner.com

Part Orders

For part order inquiries and part number research, please contact parts@bayliner.com

Troubleshooting

For pre-authorizations and troubleshooting, please contact techsupport@bayliner.com

Digital assets

Marketing resources

Bayliner's Digital Asset Library provides a host of resources you can utilize to engage your customers with compelling branded content and up-to-date product information. Visit the Digital Asset Library for product spec sheets, catalogs, POP materials and other brand assets at marketing.bayliner.com.

Bayliner image gallery

This is Bayliner's easy-to-use online archive of product and lifestyle imagery. The Image Gallery houses three years' worth of product shots, as well as editorial images—all available for download and use for your marketing purposes at bayliner.smugmug.com.

Bayliner on social media

Bayliner has an ever-growing presence on Facebook, YouTube, TikTok and Instagram, with over 100,00 fans on Facebook alone.

facebook.com/baylinerboats
youtube.com/user/baylinerboating
tiktok.com/@baylinerboats
instagram.com/baylinerboats
youtube.com/@bayliner

What is Bayliner all about?



Bowriders

Proven
Stylish
Value

- ...Leading runabout brand for more than 65 years
- ...Sporty design and well-appointed interior
- ...More boat for your money, with interior space, storage and features

Deck Boats

Stable
Social
Versatile
Value

- ...Wide beam provides exceptional stability
- ...Spacious layout for passengers, gear and entertaining
- ...Configurations allow you to cruise, cove, fish or enjoy tow sports
- ...More interior space, storage and amenities for your money

Center Consoles

Versatile
Easy
Affordable

- ...The fishable platform can also be used for tow sports or cruising
- ...Easy to operate, launch/retrieve, trailer, and maintain
- ...Priced for mass appeal

Our brand

Affordable

Bayliner is the value leader in recreational boating.

BENEFITS:

Easy to purchase
Feature/price balance

Widely Known

Bayliner has been putting families around the world on the water for more than 65 years.

BENEFITS:

Peace of mind
Enhanced resale value

Intuitive

Bayliner designs products that are usable and inviting to boaters of all skill levels.

BENEFITS:

Ease of use
Multi-use

Fit for Purpose

Bayliner serves owners who simply love spending time on the water with family and friends.

BENEFITS:

Multi-year CSI Award recipient
Industry leading warranty coverage



Our dealers

Professionalism

Nurture a reputation in your community as good people to do business with.

FOCUS:

Facility is clean, inviting and fully featured
Staff is courteous, knowledgeable and attentive

Visible

Foster community connection through all walks of life to grow your business, your people and your customer base.

FOCUS:

Digitally proficient
Promotionally driven
Event-minded

Customer experience

Respect for the customer balanced with an attitude of fairness that nurtures our mutual business relationship.

FOCUS:

Listen
Follow up and through



Our people

Winning attitude

A mindset that going above and beyond is standard operating procedure.

ATTRIBUTES:

Positive attitude
Can-do approach

Relationship

Communication creates a human connection.

ATTRIBUTES:

Ability to build rapport
Humble and empathetic

Professionalism

Conduct yourself according to the Golden Rule:
Treat others the way you would like to be treated.

ATTRIBUTES:

Courteous
Respectful

Customer service

Respect for the customer balanced with an attitude of fairness that nurtures our mutual business relationship.

ATTRIBUTES:

Active listener
Successful follow-up and follow through



Parts and accessories

Bayliner offers a wide variety of optional parts and accessories for each boat model. Some are available as an option with the boat at the time of manufacture, others are available at a later date through our Parts Department. Our Parts Department also exclusively offers specialized options for several models. A list of the available options is provided by model in this handbook. Dealers can order Parts & Accessories through COMPASS > Parts > Orders

Questions/comments? Please contact our **Customer Service Department at (865) 971-6232** or through the toll-free parts and service line we have established for your territory.

Deck boat, optional add-ons



Bimini top



Bow filler cushions



Ski pylon, outboard models only



Portable head



Extended swim platform (stern drive models only)



Premium upholstery



Bow table



Bow wind block (requires bow filler cushion)

Bowrider, optional add-ons



Bimini top



Bow filler cushions



Bow well and cockpit cover



Cockpit table



Extended swim platform, stern drive models only



Coastline upholstery



ProArc Tower

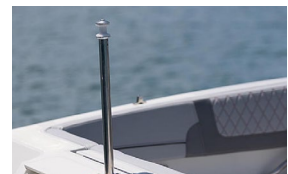

Ski pylon, outboard models only



Windshield with opening center panel



Digital dash w/USB and charging ports



M15

LENGTH OVERALL (LOA)	15' 2"	4.6 M
WIDTH (BEAM)	6' 7"	2 M
MAX PEOPLE CAPACITY	5	5
MAX HORSEPOWER	60 HP	60 HP
DEADRISE	17°	17°
APPROX WEIGHT W/ STANDARD ENGINE	1,385 LBS	628 KG
APPROX WEIGHT W/ TRAILER	1,755 LBS	796 KG
MAX PEOPLE WEIGHT	700 LBS	318 KG
FUEL CAPACITY	12 GAL	45 L
DRAFT DOWN	2' 1"	0.61 M
HEIGHT ON TRAILER ¹	5' 9"	1.6 M
BEAM ON TRAILER	7' 1"	2.13 M
STORAGE LENGTH ²	17' 5"	5.3 M
BRIDGE CLEARANCE	3'	0.9 M

Specification dimensions are approximate and subject to variance.

¹ Tongue jack lowered all the way down.

² Stern drive in down position and trailer tongue swung to side.

Colors, graphics and some equipment shown, subject to change without notice.



Standard features

Electrical

Bilge Pump (Automatic)

Cockpit

Cup Holders (5)
Grab Handles (3)
Mooring Cleats (4)

Engine

40 HP Mercury® Fourstroke ELPT

Helm

Dual Purpose Gauge: Speedometer, Voltmeter
12V Accessory Outlet
12V Horn
Side-Mounted Engine Controls w/ Trim & Tilt Switch In Handle
Custom Sport Steering Wheel

Hull & Deck

Bow & Transom Eyes (3)
12V Navigation Lights
M-Hull Design for Added Stability
Fiberglass Floor Liner
Helm Windscreen
Swim Platform w/ Telescoping Ladder

Trailer

Single Axle Painted Trailer w/ Swing Tongue (Black)



M15

BAYLINER™

Exterior color

- Solid White Hull
- Solid Rally Red hull
- Solid Black hull

Interior color

- Gray w Black accent
- Gray w Red accent



Optional add-on

- 50 HP Mercury Fourstroke ELPT
- 60 HP Mercury® FourStroke ELPT
- VesselView® Mobile
- High Altitude Prop
- Ski Tow Pylon
- Cockpit Flooring (Gray Mat) ★
- Single Axle Galvanized Trailer

MX Package

Includes Standard Features plus:

- Waterproof 120-Watt AM/FM Stereo w/ Bluetooth Capability ★
- Bimini, 6' Top w/ Boot ★
- Mooring Cover ★

M Comfort Package

Includes Standard Features plus:

- Bow Filler Cushion ★
- Digital Depth Indicator
- Portside Lounge Seat
- Stainless Steel Package (Cup Holders, Grab Rails, Fuel Fill, Thru Hull, Horn Vent, Bow Hatch, Latches, Rub Rail)

★ Popular option





Features

1. Simple and intuitive helm controls
2. Lightweight model for easy storage, trailering and handling
3. Nook-style cockpit configuration, optimized for socializing seating
4. Beam forward design allowing more room for passenger comfort and storage
5. Premium stitched upholstery
6. Molded-in storage and cup holders
7. Award-winning Mercury® engine performance and reliability
8. Filler cushion turns bow into a sun lounger
9. M-Hull foundation that allows ease on and off trailer due to M-Hull design and trailer bunks configuration.





M17

LENGTH OVERALL (LOA)	17' 0"	5.18 M
WIDTH (BEAM)	7' 6"	2.30 M
MAX PEOPLE CAPACITY	7	7
MAX HORSEPOWER	90 HP	90 HP
DEADRISE	16°	16°
APPROX WEIGHT W/ STANDARD ENGINE	1,984 LBS	900 KG
APPROX WEIGHT W/ TRAILER	2,457 LBS	1,115 KG
MAX PEOPLE WEIGHT	1,000 LBS	454 KG
FUEL CAPACITY	18 GAL	72 L
DRAFT DOWN	2' 3"	0.61 M
HEIGHT ON TRAILER ¹	6' 8"	1.83 M
BEAM ON TRAILER	8' 3"	2.51 M
STORAGE LENGTH ²	20' 1"	6.10 M
BRIDGE CLEARANCE W/ OPTIONS	3' 5"	1.06 M

Specification dimensions are approximate and subject to variance.

¹ Tongue jack lowered all the way down.

² Stern drive in down position and trailer tongue swung to side.

Colors, graphics and some equipment shown, subject to change without notice.



Standard features

Electrical

Battery Switch
Bilge Pump (Automatic)

Cockpit

Cup Holders (9)
Grab Handles (4)
Mooring Cleats (4)

Fuel

18 Gal Internal Tank w/ Integrated Vent

Engine

60 HP Mercury® FourStroke EFI Outboard

Helm

Multi-Purpose Gauge: Speedometer, Voltmeter, Fuel
12V Accessory Outlet
12V Horn
Side-Mounted Engine Controls w/ Trim & Tilt Switch In Handle
Custom Sport Steering Wheel

Hull & Deck

Bow & Transom Eyes (3)
12V Navigation Lights
M-Hull Design for Added Stability
Fiberglass Floor Liner
Single Helm Windscreen
Swim Platform w/ Telescoping Ladder

Trailer

Single Axle Painted Trailer w/ Swing Tongue (Black)



Exterior color

- Solid White Hull
- Solid Rally Red hull
- Solid Impulse Blue hull
- Solid Black hull

Interior color

- Gray w Black accent
- Gray w Blue accent
- Gray w Red accent



Optional add-ons

OB Engines

- 60 HP Command Thrust Fourstroke Outboard (Black)
- 75 HP Mercury® FourStroke EFI Outboard
- 90 HP Mercury® FourStroke EFI Outboard

Convenience Options

- Dual Acrylic Windscreen
- High Altitude Prop
- VesselView® Mobile
- Hydraulic Steering
- Full Windshield w/ Opening CTR Panel

Floor Covering

- Cockpit Flooring Mat (Gray) ★

Water Sports

- Ski Tow Pylon ★

Trailer

- Single Axle Galvanized Trailer

MX Package

Includes Standard Features plus:

- Bimini, 6' Top w/ Boot
- Waterproof 120-Watt AM/FM Stereo W/ Bluetooth
- Snap-On Bow Well & Cockpit Cover ★

M Comfort Package

Includes Standard Features plus:

- Bow Filler Cushion
- Digital Depth Indicator ★
- Bow Speakers (2)
- Stainless Steel Package (Cup Holders, Grab Rails, Fuel Fill, Thru Hull, Horn Vent, Bow Hatch, Latches, Rub Rail)
- Bow Block-Off
- Portside Lounge Seat
- Cooler
- Cockpit Table





Features

1. Simple and intuitive helm controls
2. Lightweight model for easy storage, trailering and handling
3. Nook-style cockpit configuration, optimized for socializing seating
4. Beam forward design allowing more room for passenger comfort and storage
5. Premium stitched upholstery
6. Molded-in storage and cup holders
7. Award-winning Mercury® engine performance and reliability
8. Filler cushion turns bow into a sun lounger
9. M-Hull foundation that allows ease on and off trailer due to M-Hull design and trailer bunks configuration
10. Integrated cooler





M19



LENGTH OVERALL (LOA)	19' 0"	5.79 M
WIDTH (BEAM)	7' 6"	2.24 M
MAX PEOPLE CAPACITY	9	9
MAX HORSEPOWER	115 HP	115 HP
DEADRISE	15°	15°
APPROX WEIGHT W/ STANDARD ENGINE	2,399 LBS	1,088 KG
APPROX WEIGHT W/ TRAILER	3,009 LBS	1,365 KG
MAX PEOPLE WEIGHT	1,300 LBS	600 KG
FUEL CAPACITY	18 GAL	68 L
DRAFT DOWN	2' 1"	0.64 M
HEIGHT ON TRAILER ¹	6' 4"	1.93 M
BEAM ON TRAILER	8' 6"	2.59 M
STORAGE LENGTH ²	21' 6"	6.55 M
BRIDGE CLEARANCE W/ OPTIONS	5' 9"	1.79 M

Specification dimensions are approximate and subject to variance.

¹ Tongue jack lowered all the way down.

² Outboard motor in down position and trailer tongue swung to side.

Colors, graphics and some equipment shown, subject to change without notice.

Standard features

Electrical

Battery Switch
Bilge Pump (Automatic)

Cockpit

Cup Holders (6)
Grab Handles (4)
Mooring Cleats (4)

Engine

90 HP Mercury® FourStroke EFI Outboard

Helm

Multi-Purpose Gauge: Speedometer, Voltmeter, Fuel
12V Accessory Outlet
12V Horn
Side-Mounted Engine Controls w/ Trim & Tilt Switch In Handle
Custom Sport Steering Wheel

Hull & Deck

Bow & Transom Eyes (3)
12V Navigation Lights
M-Hull Design for Added Stability
Fiberglass Floor Liner
Single Helm Windscreen
Swim Platform w/ Telescoping Ladder
Single Windscreen
Ski Locker
Bucket Helm Seat
Portside Under Seat Storage

Trailer

Single Axle Painted Trailer w/ Swing Tongue (Black)



M19

Exterior color

- Solid White Hull
- Solid Rally Red hull
- Solid Impulse Blue hull
- Solid Black hull

Interior color

- Gray w Black accent
- Gray w Blue accent
- Gray w Red accent



Optional add-ons

OB Engines

- 115 HP Mercury® FourStroke EFI Outboard
- 115 HP Mercury Pro XS

Windscreen / Windshield

- Dual Windscreen (acrylic)
- Split Windshield with Center Panel

Convenience Options

- High Altitude Prop
- VesselView® Mobile
- Hydraulic Steering

Floor Covering

- Cockpit Flooring Mat (Gray) ★

Water Sports

- Ski Tow Pylon ★

Trailer

- Single Axle Galvanized Trailer

MX Package

Includes Standard Features plus:

- Bimini, 6' Top w/ Boot
- Waterproof 120-Watt AM/FM Stereo w/ Bluetooth
- Snap-On Bow Well & Cockpit Cover ★

M Comfort Package

Includes Standard Features plus:

- Cooler
- Stainless Steel Package (Cup Holders, Grab Rails, Fuel Fill, Thru Hull, Horn Vent, Bow Hatch, Latches, Rub Rail)
- Bow Filler Cushion
- Bow Block-Off (Requires Bow Filler Cushion)
- Bow Speakers (2)
- Cockpit Table
- Digital Depth Indicator
- Portside Lounge Seat
- Portside Storage Door





Features

1. Simple and intuitive helm controls
2. Lightweight model for easy storage, trailering and handling
3. Nook-style cockpit configuration, optimized for socializing seating
4. M-Hull foundation offers better stability and predictable handling
5. Premium stitched upholstery
6. Molded-in storage and cup holders
7. Award-winning Mercury® engine performance and reliability
8. Filler cushion turns bow into a sun lounger
9. Adjustable aft lounge
10. M-Hull foundation that allows ease on and off trailer due to M-Hull design and trailer bunks configuration
11. Ski locker





VR4



LENGTH OVERALL (LOA), I/O & OB	18' 9"	5.7 M
WIDTH (BEAM)	7' 6"	2.8 M
MAX PEOPLE CAPACITY	7	7
I/O, MAX HORSEPOWER	200 HP	200 HP
OB, MAX HORSEPOWER	150 HP	200 HP
DEADRISE	19°	19°
APPROX WEIGHT W/ STANDARD ENGINE	2,822 LBS	1,280 KG
MAX PEOPLE WEIGHT	1,155 LBS	524 KG
FUEL CAPACITY	33 GAL	125 L
DRAFT DOWN	2' 10"	0.86 M
BEAM ON TRAILER	8' 6"	2.6 M

Specification dimensions are approximate and subject to variance.
Colors, graphics and some equipment shown, subject to change without notice.

Standard features

Electrical

Battery Switch
Automatic Bilge Pump
12V Blower

Cockpit

Standard Speakers (4)
Cup Holders (6)
Mooring Cleats (4)
Fuel Fill w/ Integrated Vent
Glove Box
Helm Seat w/ 180 Degree Swivel
In-Floor Ski/Wakeboard Storage
Waterproof 120-Watt AM/FM Stereo
w/Bluetooth Capability

Trailer

Single Axle Painted Trailer w/Brakes
and Swing Tongue (Black)

Engine

200 HP MerCruiser® ECT 4.5L MPI Sterndrive (Alpha 1 Outdrive), I/O
115 HP Mercury® FourStroke EFI Outboard, OB

Helm

Multi-Function Gauges w/Fog Resistant Glass Lenses:
Fuel, Speedometer, Tachometer, Voltmeter
12V Accessory Outlet
12V Horn
Side-Mounted Engine Controls w/Trim & Tilt Switch in Handle
Tilt Steering
Custom Sport Steering Wheel
Mechanical Cable Steering (Outboard Models)
Analog Trim Indicator
Sport Windshield w/Opening Center Panel

Hull & Deck

Bow & Transom Eyes (3)
12V Navigation Lights
Fiberglass Floor Liner
Sport Windshield w/Opening Center Panel
Swim Platform w/Telescoping Ladder
V-Hull for Added Performance



Exterior color

- Solid White Hull
- Solid Rally Red hull
- Solid Black hull
- Solid Blue hull
- Solid Gray hull
- VR Sport Package (Red)
- White bottom w/ Rally Red hull
- White bottom w/ Black hull
- White bottom w/ Blue hull
- White bottom w/ Gray hull
- Impulse Blue w/ White hull
- VR Sport Package (Blue)

Interior color

- Graphite (Gray)
- Coastline (Tan)
- Gray/White

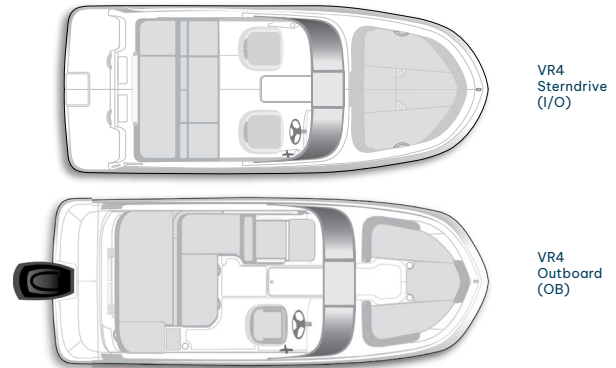

Optional add-ons

I/O Engines

- 200 HP MerCruiser® ECT 4.5L MPI Sterndrive (Alpha 1 Outdrive)
- 200 HP MerCruiser® 4.5L MPI Sterndrive (Alpha 1 Outdrive)*

OB Engines

- 115 HP Mercury® FourStroke Command Thrust EFI Outboard
- 115 HP Mercury® Pro XS XL Command Thrust Outboard
- 150 HP Mercury® FourStroke EFI Outboard
- Hydraulic Steering System (115 HP and Below)

Tops

- Bimini, 6' Top w/Boot ★
- ProArc Tower
- Tower Speaker Option

Canvas

- Snap-On Bow Well & Cockpit Cover ★

Windshield

- Windshield w/Opening Center & Side Wings

Floor Covering

- Cockpit Flooring Mat (Gray) ★
- Cockpit Flooring Mat (Tan) ★
- Woven Floor Covering (Gray)
- Woven Floor Covering (Tan)

Seats & Upholstery

- Bow Filler Cushion
- Aft Filler Cushion (OB Only)

Sound System

- Rockford Fosgate® System (4-speaker) ★

Appearance Package

- Stainless Steel Package (Cup Holders, Fuel Fill, Thru Hull, Horn Vent, Bow Hatch, Latches, Rub Rail)

Lighting

- Exterior Lighting (LED Docking Lights, 2x Rear Underwater Lights)
- Interior Lighting

Water Sports

- Wakeboard Rack (1)
- Wakeboard Rack (2)
- Ski Tow Pylon (OB Only)

Swim Platforms

- Swim Platform Mat (Gray)
- Swim Platform Mat (Teak)

Convenience Options

- Cockpit Table
- Digital Depth Indicator ★
- High Altitude Prop
- Bow Wind Block (Requires Bow Filler Cushion)
- VesselView® Mobile
- Dual Battery Trays w/Switch
- 7" Digital Dash w/Engine Data
- Wireless Phone Charger

Trailer

- Single Axle Painted Trailer w/ Brakes & Swing Tongue
- No Trailer

★ Popular option

* CANADA AND INTERNATIONAL ONLY





Engine performance data

Outboard

115 HP Mercury® FourStroke EFI Outboard

Cruise mph	28.6
WOT mph	43
Propeller	19 P Black Max
Range	N/A
Weight as tested	3,250 lbs

Sterndrive

200 HP MerCruiser® ECT 4.5L MPI Sterndrive (Alpha 1 Outdrive)

Cruise mph	34.2
WOT mph	53
Propeller	19 P Black Max
Range	N/A
Weight as tested	3,450 lbs

This information is provided for comparison purposes and is intended to show relative performance between different boats and engine options. A specific boat's performance will be affected by water and weather conditions, altitude, condition of boat, actual load, engine and propeller. Engine performance data is based on boat in cruise load weight condition. Cruise load weight condition consists of boat with typical options, full tanks, all safety gear, two passengers and typical storage. Cruising range based on cruise speed at cruise load with 10% fuel reserve at rated range.

Features

1. Simple and intuitive helm controls
2. Lightweight model for easy storage, trailering and handling
3. Spacious cockpit for socializing
4. V-Hull allows for a smooth ride with higher speed and improved performance
5. High attention to detail, fit and finish with premium stitched upholstery
6. Molded-in storage and cup holders
7. Award-winning Mercury® engine performance and reliability
8. Filler cushion turns bow into a sun lounger
9. Large sunpad





VR5



LENGTH OVERALL (LOA), I/O & OB	20' 7"	6.09 M
WIDTH (BEAM)	8' 0"	2.43 M
MAX PEOPLE CAPACITY, I/O	8	8
MAX PEOPLE CAPACITY, OB	9	9
MAX HORSEPOWER, I/O	250 HP	250 HP
MAX HORSEPOWER, OB	200 HP	250 HP
DEADRISE	20°	20°
MAX PEOPLE WEIGHT, I/O	1,323 LBS	600 KG
MAX PEOPLE WEIGHT, OB	1,537 LBS	697 KG
FUEL CAPACITY	33 GAL	125 L
DRAFT DOWN	2' 8"	0.6 M
BEAM	8' 0"	2.43 M
BEAM ON TRAILER	8' 6"	2.6 M

Specification dimensions are approximate and subject to variance.
Colors, graphics and some equipment shown, subject to change without notice.

Standard features

Electrical

Automatic Bilge Pump
12V Blower

Cockpit

Integrated Cooler
Speakers (4)
Cup Holders (5)
Grab Handles (5)
Mooring Cleats (6)
Fuel Fill w/ Integrated Vent
Glove Box
Helm Seat w/ 180 Degree Swivel
In-Floor Ski/Wakeboard Storage
Waterproof 120-Watt AM/FM Stereo
w/Bluetooth Capability

Engine

200 HP MerCruiser® ECT 4.5L MPI Sterndrive (Alpha 1 Outdrive), I/O
115 HP Mercury® FourStroke EFI Outboard, OB

Helm

Multi-Function Gauges w/ Fog Resistant Glass Lenses: Fuel, Speedometer, Tachometer, Voltmeter
12V Accessory Outlet
12V Horn
Side-Mounted Engine Controls w/ Trim & Tilt Switch in Handle
Tilt Steering
Custom Sport Steering Wheel
Analog Trim Indicator

Hull & Deck

Bow & Transom Eyes (3)
12V Navigation Lights
Stainless Steel Tow Ring (I/O Only)
Fiberglass Floor Liner
Sport Windshield w/ Opening with Central Panel
Swim Platform w/ Telescoping Ladder
V-hull for Added Performance

Trailer

Single Axle Painted Trailer w/ Brakes and Swing Tongue (Black)



Exterior color

- Solid White Hull
- Solid Rally Red hull
- Solid Black hull
- Solid Blue hull
- Solid Gray hull
- VR Sport Package (Red)
- White bottom w/ Rally Red hull
- White bottom w/ Black hull
- White bottom w/ Blue hull
- White bottom w/ Gray hull
- Impulse Blue w/ White hull
- VR Sport Package (Blue)

Interior color

- Graphite (Gray)
- Coastline (Tan)
- Gray/White

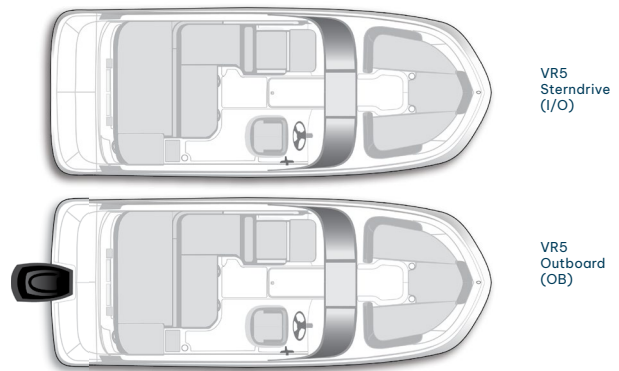

Optional add-ons

I/O Engines

- 200 HP MerCruiser® ECT 4.5L MPI Sterndrive (Alpha 1 Outdrive)
- 250 HP MerCruiser® ECT 4.5L MPI Sterndrive (Alpha 1 Outdrive)
- 200 HP MerCruiser® 4.5L MPI Sterndrive (Alpha 1 Outdrive)*
- 250 HP MerCruiser® 4.5L MPI Sterndrive (Alpha 1 Outdrive)*

OB Engines

- 115 HP Mercury® FourStroke CommandThrust EFI Outboard
- 115 HP Mercury® Pro XS XL Outboard
- 150 HP Mercury® FourStroke EFI Outboard

Tops

- Bimini, 6' Top w/ Boot ★
- ProArc Tower w/ Integrated Top
- Tower Speaker Option

Canvas

- Snap-On Bow Well & Cockpit Cover ★
- Privacy Curtain OB only

Windshield

- Windshield w/ Opening Center & Side Wings

Floor Covering

- Cockpit Flooring (Gray Mat) ★
- Cockpit Flooring (Tan Mat) ★
- Snap-In Seagrass Woven Floor Covering (Tan)
- Snap-In Seagrass Woven Floor Covering (Gray)
- Cockpit Carpet Runners

Seats & Upholstery

- Bow Filler Cushion

Sound System

- Rockford Fosgate® System (4-speaker) ★

Appearance Package

- Stainless Package (Cup Holders, Fuel Fill, Thru Hull, Horn Vent, Bow Hatch, Latches, Rub Rail)
- VR Sport Package (Blue)
- VR Sport Package (Red)

Lighting

- Exterior Lighting (LED Docking Lights, 2x Rear Underwater Lights)
- Interior Lighting

Water Sports

- Wakeboard Rack (1)
- Wakeboard Rack (2)
- Ski Tow Pylon (OB Only)

Swim Platforms

- Swim Platform Mat (Gray)
- Swim Platform Mat (Teak)

Convenience Options

- 7" Glass Dash Screen w/ Engine Data
- 9" Glass Dash Screen w/ Engine Data
- Wireless Phone Charger
- Cockpit Table
- Digital Depth Indicator ★
- Dual Battery Trays w/Switch
- High Altitude Prop
- Bow Wind Block (Requires Bow Filler Cushion)
- VesselView® Mobile

Trailer

- Single Axle Galvanized Trailer w/ Brakes & Swing Tongue
- Single Axle Painted Trailer w/ Brakes and Swing Tongue (Black)
- Tandem Axle Trailer w/ Brakes (Black)
- Tandem Axle Trailer w/ Brakes (Galv)

★ Popular option

* CANADA AND INTERNATIONAL ONLY





Engine performance data

Outboard

150 HP Mercury® FourStroke EFI Outboard

Cruise mph	35.4
WOT mph	53
Propeller	7 P Black Max
Range	N/A
Weight as tested	4,240 lbs

Sterndrive

250 HP MerCruiser® 4.5L MPI Sterndrive (Alpha 1 Outdrive)

Data Not Yet Available

200 HP MerCruiser® ECT 4.5L MPI Sterndrive (Alpha 1 Outdrive)

Cruise mph	34.2
WOT mph	47
Propeller	21 P Black Max
Range	109 nm
Weight as tested	4,028 lbs

This information is provided for comparison purposes and is intended to show relative performance between different boats and engine options. A specific boat's performance will be affected by water and weather conditions, altitude, condition of boat, actual load, engine and propeller. Engine performance data is based on boat in cruise load weight condition. Cruise load weight condition consists of boat with typical options, full tanks, all safety gear, two passengers and typical storage. Cruising range based on cruise speed at cruise load with 10% fuel reserve at rated range.

Features

1. Simple, intuitive controls at the helm
2. Lightweight model for easy storage, trailering and handling
3. Large cockpit with adjustable seating for entertaining or lounging
4. V-Hull allows for a smooth ride with higher speed and less splashing
5. Premium stitched upholstery
6. Molded-in storage and cup holders
7. Award-winning Mercury® engine performance and reliability
8. Filler cushion turns bow into a sun lounger
9. Large sunpad
10. Integrated ski locker
11. Flip up headrest





VR6

LENGTH OVERALL (LOA), I/O & OB	22' 7"	6.9 M
WIDTH (BEAM)	8' 0"	2.44 M
MAX PEOPLE CAPACITY, I/O	10	10
MAX PEOPLE CAPACITY, OB	10	10
MAX HORSEPOWER, I/O	250 HP	250 HP
MAX HORSEPOWER, OB	200 HP	200 HP
DEADRISE	20°	20°
APPROX WEIGHT W/ STANDARD ENGINE	3,797 LBS	1,722 KG
MAX PEOPLE WEIGHT, I/O	1,700 LBS	771 KG
MAX PEOPLE WEIGHT, OB	1,654 LBS	750 KG
FUEL CAPACITY	33 GAL	125 L
BEAM ON TRAILER	8' 6"	2.6 M



Specification dimensions are approximate and subject to variance.
Colors, graphics and some equipment shown, subject to change without notice.

Standard features

Electrical

Battery Switch
Automatic Bilge Pump
12V Blower

Cockpit

Speakers (4), Cup Holders (6)
Grab Handles, Mooring Cleats (6)
Fuel Fill w/ Integrated Vent
Glove Box
Helm Seat w/ 180 Degree Swivel
In-Floor Ski/Wakeboard Storage
Portside Companion Seat (3-Position)
Large Lockable Port-Side Changing
Room and Storage Compartment
Self-Bailing Cockpit
Integrated Cooler
Waterproof 120-Watt AM/FM Stereo
w/ Bluetooth Capability

Engine

200 HP MerCruiser® ECT 4.5L MPI Sterndrive (Alpha 1 Outdrive), I/O
150 HP Mercury® FourStroke EFI Outboard, OB

Helm

Multi-Function Gauges w/ Fog Resistant Glass Lenses
12V Accessory Outlet
12V Horn
Side-Mounted Engine Controls w/ Trim & Tilt Switch in Handle
Tilt Steering
Custom Sport Steering Wheel
Analog Trim Indicator

Hull & Deck

Bow & Transom Eyes (3)
12V Navigation Lights
Stainless Steel Tow Ring (I/O only)
Fiberglass Floor Liner
Sport Windshield w/ Opening Center Panel
Swim Platform w/ Telescoping Ladder
V-Hull for Added Performance

Trailer

Tandem Axle Painted Trailer w/ Brakes & Swing Tongue (Black)

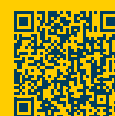

Exterior color

- Solid White Hull
- Solid Rally Red hull
- Solid Black hull
- Solid Blue hull
- Solid Gray hull
- VR Sport Package (Red)
- White bottom w/ Rally Red hull
- White bottom w/ Black hull
- White bottom w/ Blue hull
- White bottom w/ Gray hull
- Impulse Blue w/ White hull
- VR Sport Package (Blue)

Interior color

- Graphite (Gray)
- Coastline (Tan)
- Gray/White

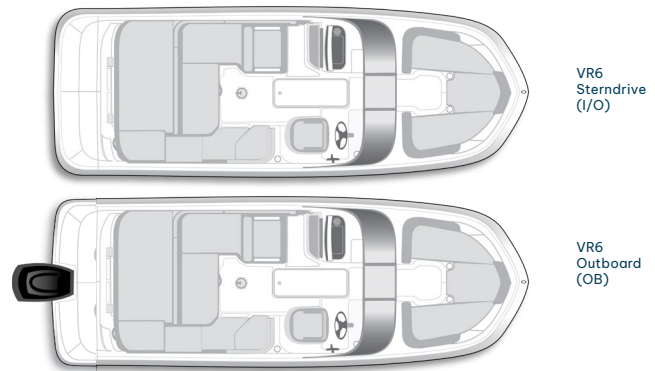

Optional add-ons

I/O Engines

- 200 HP MerCruiser® ECT 4.5L MPI Sterndrive (Alpha 1 Outdrive)
- 200 HP MerCruiser® 4.5L MPI Sterndrive (Alpha 1 Outdrive)*
- 250 HP MerCruiser® ECT 4.5L MPI Sterndrive (Alpha 1 Outdrive)
- 250 HP MerCruiser® 4.5L MPI Sterndrive (Alpha 1 Outdrive)*

OB Engines

- 200 HP Mercury® FourStroke Outboard (Black)
- High Altitude Prop

Steering

- Power Steering - 200HP L4 Option, OB

Tops

- Bimini, 6' Top w/ Boot ★
- ProArc Tower w/ Integrated Top
- Tower Speaker Option

Canvas

- Snap-On Bow Well & Cockpit Cover ★

Windshield

- Windshield w/ Opening Center & Side Wings

Floor Covering

- Cockpit Flooring (Gray Mat) ★
- Cockpit Flooring (Tan Mat) ★
- Snap-In Seagrass Woven Floor Covering (Tan)
- Snap-In Seagrass Woven Floor Covering (Gray)

Seats & Upholstery

- Bow Filler Cushion

Appearance Package

- Stainless Package
- VR Sport Package (Blue)
- VR Sport Package (Red)

Sound System

- Rockford Fosgate® System (4-speaker) ★

Lighting

- Exterior Lighting
- Interior Lighting

Water Sports

- Wakeboard Rack (1x)
- Wakeboard Rack (2x)
- Ski Tow Pylon (OB only)

Swim Platforms

- Swim Platform Mat (Gray)
- Swim Platform Mat (Teak)

Convenience Options

- 7" Glass Dash Screen w/ Engine Data
- 9" Glass Dash Screen w/ Engine Data
- Privacy Curtain
- Cockpit Table
- Digital Depth Indicator ★
- Portable Head
- Bow Wind Block (Requires Bow Filler Cushion)
- VesselView® Mobile
- Dual Battery Trays w/Switch
- Wireless Phone Charger

Trailer

- Tandem Axle Galvanized Trailer w/ Brakes & Swing Tongue
- Tandem Axle Painted Trailer w/ Brakes & Swing Tongue (Black)

★ Popular option

* CANADA AND INTERNATIONAL ONLY





Engine performance data

Outboard

150 HP Mercury® FourStroke EFI Outboard

Data Not Yet Available

200 HP 4 Stroke L6 Verado

Data Not Yet Available

Sterndrive

200 HP MerCruiser® ECT 4.5L MPI Sterndrive (Alpha 1 Outdrive)

Cruise mph	32.8
WOT mph	45.8
Propeller	19 P Black Max
Range	104.3 nm
Weight as tested	4,430 lbs

250 HP Mercury 4.5L A1 Sterndrive

Cruise mph	32.3
WOT mph	49.9
Propeller	17 P Enertia
Range	102.9 nm
Weight as tested	4,430 lbs

250 HP Mercury 4.5L B3 Sterndrive Data Not Yet Available

This information is provided for comparison purposes and is intended to show relative performance between different boats and engine options. A specific boat's performance will be affected by water and weather conditions, altitude, condition of boat, actual load, engine and propeller. Engine performance data is based on boat in cruise load weight condition. Cruise load weight condition consists of boat with typical options, full tanks, all safety gear, two passengers and typical storage. Cruising range based on cruise speed at cruise load with 10% fuel reserve at rated range.

Features

1. Simple, intuitive controls at the helm
2. Lightweight model for easy storage, trailering and handling
3. Large cockpit with adjustable seating for lounging or entertaining
4. V-Hull allows for a smooth ride with higher speed and improved performance
5. Premium stitched upholstery
6. Molded-in storage and cup holders
7. Award-winning Mercury® engine performance and reliability
8. Filler cushion turns bow into a sun lounger
9. Large sunpad w/integrated headrest
10. Integrated ski locker





D20

LENGTH OVERALL (LOA)	19' 6"	5.9 M
WIDTH (BEAM)	8' 1"	2.46 M
MAX PEOPLE CAPACITY	10	10
MAX HORSEPOWER	150 HP	150 HP
DEADRISE	18°	18°
MAX PEOPLE WEIGHT	1,643 LBS	745 KG
FUEL CAPACITY	33 GAL	124.9 L
DRAFT DOWN	2' 11"	0.64 M
BEAM ON TRAILER	8' 6"	2.46 M



Specification dimensions are approximate and subject to variance.
Colors, graphics and some equipment shown, subject to change without notice.

Standard features

Electrical

Battery Switch
Automatic Bilge Pump

Cockpit

Standard Speakers (4)
Mooring Cleats (6)
Cup Holders
Grab Handles
Fuel Fill w/ Integrated Vent
Helm Seat w/ 180° Swivel
In-Floor Ski/Wakeboard Storage
Waterproof 120-Watt AM/FM Stereo
w/ Bluetooth Capability

Engine

115 HP XL EFI 4 Stroke, Mercury OB
150 HP EFI 4 Stroke, Mercury OB

Helm

Multi-Function Gauges w/ Fog Resistant Glass Lenses:
Fuel, Speedometer, Tachometer, Voltmeter
12V Accessory Outlet
12V Horn
Side-Mounted Engine Controls w/ Trim & Tilt Switch in Handle
Tilt Steering
Mechanical Cable Steering (Outboard Models)
Analog Trim Indicator
Custom Sport Steering Wheel

Hull & Deck

Bow & Transom Eyes (3)
12V Navigation Lights
Bow Ladder w/ Hinged Lid
Anchor Locker
Fiberglass Floor Liner
Swim Platform w/ Telescoping Ladder



D20

BAYLINER™

Exterior color

- Solid Black hull
- Solid Blue hull
- Solid Gray hull
- Black w/ White bottom
- Blue w/ White bottom
- Gray w/ White bottom

Interior color

- Gray/White
- Coastline (Tan)



Optional add-ons

OB Engines

- 150 HP EFI 4 Stroke - Mercury Outboard
- Blank - Mercury Outboard Up to 125HP
- Blank - Mercury Outboard 135HP and Higher
- 115 HP XL 4 Stroke EFI CMD Thrust, Mercury OB
- High Altitude Prop

Floor Covering

- Flooring (Teak Mat)
- Flooring (Gray Mat)

Seats & Upholstery

- DX Series Gray/White Interior
- DX Series Coastline Interior (Tan)

Trailer

- Painted Swing Tongue S/ A Trailer W/ Brakes
- Galv Swing Tongue S/ A Trailer With Brakes
- Australian Trailer Upgrade
- 15' to 20' Cradle

Max Layout Package

Includes Standard Features plus:

- L-Shaped Cockpit Layout
- Snap On Cover
- Wireless Phone Charger

Dual Console Package

Includes Standard Features plus:

- Dual Console Layout w/ Windshield
- Snap On Cover
- Wireless Phone Charger

Bimini Package

Includes Standard Features plus:

- Stainless Steel Upgrade
- Bimini Top w/ Boot
- Battery Switch Dual w/ 2nd Tray Single Engine

Tower Package

Includes Standard Features plus:

- Stainless Steel Upgrade
- Proarc Tower/Integrated Top
- Battery Switch Dual w/ 2nd Tray Single Engine

Comfort Package

Includes Standard Features plus:

- Bow Filler Cushion
- Cockpit Table
- Stereo Rockford Fosgate





Engine performance data

Outboard

115 HP Mercury FS CT XL Outboard

Cruise mph	22
WOT mph	31
Propeller	.Black Max 15x17P
Range	.96 nm
Weight as tested	.4,062 lbs

150 HP Mercury FS XL Outboard

Cruise mph	32.3
WOT mph	41
Propeller	.Black Max 15x17P
Range	.118 nm
Weight as tested	.4,210 lbs

This information is provided for comparison purposes and is intended to show relative performance between different boats and engine options. A specific boat's performance will be affected by water and weather conditions, altitude, condition of boat, actual load, engine and propeller. Engine performance data is based on boat in cruise load weight condition. Cruise load weight condition consists of boat with typical options, full tanks, all safety gear, two passengers and typical storage. Cruising range based on cruise speed at cruise load with 10% fuel reserve at rated range.

Features

1. Award winning Mercury engine
2. Premium stitched upholstery
3. Deep gunnels for a safe, dry ride
4. Transitional seating creates ample sun lounging area
5. Ample storage space





D201

LENGTH OVERALL (LOA)	19' 6"	6 M
WIDTH (BEAM)	8' 1"	2.46 M
MAX PEOPLE CAPACITY	9	9
MAX HORSEPOWER	250 HP	250 HP
DEADRISE	18°	18°
MAX PEOPLE WEIGHT	1,270 LBS	575 KG
FUEL CAPACITY	33 GAL	124.9 L
DRAFT DOWN	2' 11"	0.64 M
BEAM ON TRAILER	8' 6"	2.46 M



Specification dimensions are approximate and subject to variance.
Colors, graphics and some equipment shown, subject to change without notice.

Standard features

Electrical

Battery Switch
Automatic Bilge Pump

Cockpit

Standard Speakers (4)
Mooring Cleats (6)
Cup Holders
Grab Handles
Fuel Fill w/ Integrated Vent
Helm Seat w/ 180° Swivel
In-Floor Ski/Wakeboard Storage
Waterproof 120-Watt AM/FM Stereo
w/ Bluetooth Capability

Engine

200 HP MerCruiser® ECT 4.5L MPI Sterndrive
(Alpha 1 Outdrive)

Helm

Multi-Function Gauges w/ Fog Resistant Glass Lenses:
Fuel, Speedometer, Tachometer, Voltmeter
12V Accessory Outlet
12V Horn
Side-Mounted Engine Controls w/ Trim & Tilt Switch in Handle
Tilt Steering
Mechanical Cable Steering (Outboard Models)
Analog Trim Indicator
Custom Sport Steering Wheel

Hull & Deck

Bow & Transom Eyes (3)
12V Navigation Lights
Bow Ladder w/ Hinged Lid
Anchor Locker
Fiberglass Floor Liner
Swim Platform w/ Telescoping Ladder



D20I



Exterior color

- Solid Black hull
- Solid Blue hull
- Solid Gray hull
- Black w/ White bottom
- Blue w/ White bottom
- Gray w/ White bottom

Interior color

- Gray/White
- Coastline (Tan)



Optional add-ons

I/O Engines

- Pre-Rig - Blank V6 Mercury DTS
- High Altitude Prop
- 250 M Mpi/A1 (4.5L) Ect Carb Compliant

Floor Covering

- Flooring (Teak Mat)
- Flooring (Gray Mat)

Seats & Upholstery

- DX Series Gray/White Interior
- DX Series Coastline Interior (Tan)

Trailer

- Painted Swing Tongue S/ A Trailer W/ Brakes
- Galv Swing Tongue S/ A Trailer With Brakes
- Australian Trailer Upgrade
- 15' to 20' Cradle

Convenience Options

- Transom Shower
- Bow Table
- VesselView® Mobile
- Digital Depth Indicator
- Simrad 7" Digital Dash w/VesselView Link
- Bow Block Off (Req. Bow Filler Cushion)
- Exterior Lighting Package

Max Layout Package

Includes Standard Features plus:

- L-Shaped Cockpit Layout
- Snap On Cover
- Wireless Phone Charger

Dual Console Package

Includes Standard Features plus:

- Dual Console Layout w/ Windshield
- Snap On Cover
- Wireless Phone Charger

Bimini Package

Includes Standard Features plus:

- Stainless Steel Upgrade
- Bimini Top w/ Boot
- Battery Switch Dual w/ 2nd Tray Single Engine

Tower Package

Includes Standard Features plus:

- Stainless Steel Upgrade
- Proarc Tower/Integrated Top
- Battery Switch Dual w/ 2nd Tray Single Engine

Comfort Package

Includes Standard Features plus:

- Bow Filler Cushion
- Cockpit Table
- Stereo Rockford Fosgate





Engine performance data

Sterndrive

200 HP Mercury 4.5L V6 Alpha Sterndrive

Cruise mph	30.15
WOT mph	40.2
Propeller	Spitfire 14x17P
Range	95 nm
Weight as tested	4,616 lbs

250 HP Mercury 4.5L V6 Alpha Sterndrive

Cruise mph	42.7
WOT mph	49.7
Propeller	Spitfire 14x17P
Range	70 nm
Weight as tested	4,616 lbs

This information is provided for comparison purposes and is intended to show relative performance between different boats and engine options. A specific boat's performance will be affected by water and weather conditions, altitude, condition of boat, actual load, engine and propeller. Engine performance data is based on boat in cruise load weight condition. Cruise load weight condition consists of boat with typical options, full tanks, all safety gear, two passengers and typical storage. Cruising range based on cruise speed at cruise load with 10% fuel reserve at rated range.

Features

1. Award winning Mercury engine
2. Premium stitched upholstery
3. Deep gunnels for a safe, dry ride
4. Transitional seating creates ample sun lounging area
5. Ample storage space





D22

LENGTH OVERALL (LOA)	21' 6"	6.5 M
WIDTH (BEAM)	8' 6"	2.6 M
MAX PEOPLE CAPACITY	12	12
MAX HORSEPOWER	225 HP	225 HP
DEADRISE	18°	18°
MAX PEOPLE WEIGHT	1,692 LBS	767.4 KG
FUEL CAPACITY	55 GAL	208.2 L
DRAFT DOWN	2' 9"	0.88 M
BEAM ON TRAILER	8' 6"	2.6 M



Specification dimensions are approximate and subject to variance.
Colors, graphics and some equipment shown, subject to change without notice.

Standard features

Electrical

- Battery Switch
- Automatic Bilge Pump

Cockpit

- Standard Speakers (4)
- Cup Holders (4)
- Mooring Cleats (6)
- Grab Handles (8)
- Fuel Fill w/ Integrated Vent
- Helm Seat w/ 180 Degree Swivel
- In-Floor Ski/Wakeboard Storage
- Waterproof 120-Watt AM/FM Stereo w/ Bluetooth Capability

Engine

- 150 HP Mercury OB Non-DTS

Helm

- Multi-Function Gauges w/ Fog Resistant Glass Lenses: Fuel, Speedometer, Tachometer, Voltmeter
- 12V Horn
- 12V Accessory Outlet
- Side-Mounted Engine Controls w/ Trim & Tilt Switch in Handle
- Tilt Steering
- Analog Trim Indicator

Hull & Deck

- Bow & Transom Eyes (3)
- 12V Navigation Lights
- Bow Ladder w/ Hinged Lid
- Fiberglass Floor Liner



Exterior color

- Solid Black hull
- Solid Gray hull
- Solid Blue hull
- Black w/ White bottom
- Blue w/ White bottom

Interior color

- Coastline (Tan)
- Gray/White



Optional add-ons

OB Engines

- 200HP Black Mercury Fourstroke OB Non-DTS
- 150 HP EFI 4 Stroke Mercury OB

Floor Covering

- Cockpit Flooring (Gray Mat) ★
- Cockpit Flooring (Teak Mat) ★

Lighting

- Exterior Lighting (LED Docking Lights, 2x Rear Underwater Lights)

Water Sports

- Wakeboard Rack (1)
- Wakeboard Rack (2)

Trailer

- Tandem Axle Painted Trailer w/Brakes
- Tandem Axle Galvanized Trailer w/Brakes

Convenience Options

- Digital Depth Indicator ★
- Full Windshield w/ Opening Control Panel
- VesselView® Mobile
- Bow Block Off (Req. Bow Filler Cushion)
- Simrad 7" Digital Dash VesselView Link
- Simrad 9" Digital Dash VesselView Link
- Transom Shower
- Portable Head
- Bow Table

Tower Package

Includes Standard Features plus:

- Bow Well and Cockpit Cover
- Snap-On Cover
- Stainless Steel
- Battery Switch-Dual 1/ 2nd Tray Single Engine
- ProArc Tower w/ Integrated Top
- Wireless Phone Charger

Bimini Package

Includes Standard Features plus:

- Snap-On Cover
- Stainless Steel
- Bimini Top w/ Boot
- Ski Tow Pylon
- Battery Switch-dual w/ 2nd tray single engine

Comfort Package

Includes Standard Features plus:

- Cockpit Table
- Bow Block Off (Req. Bow Filler Cushion)
- Bow Filler Cushion
- Stereo, Rockford Fosgate

Fishing Package

Includes Standard Features plus:

- Bow Casting Platform
- Aerated Live Well
- Fish Finder
- Dual Battery E/24V Plug





Engine performance data

Outboard

150 HP Mercury I4 FS XL Outboard

Cruise mph	30.2
WOT mph	38.6
Propeller	BlackMax 15.25x15P
Range	144 nm
Weight as tested	5,199 lbs

200 HP Mercury V6 FS XL Outboard

Cruise mph	32.2
WOT mph	44.1
Propeller	Enertia 15x15P
Range	142 nm
Weight as tested	5,244 lbs

This information is provided for comparison purposes and is intended to show relative performance between different boats and engine options. A specific boat's performance will be affected by water and weather conditions, altitude, condition of boat, actual load, engine and propeller. Engine performance data is based on boat in cruise load weight condition. Cruise load weight condition consists of boat with typical options, full tanks, all safety gear, two passengers and typical storage. Cruising range based on cruise speed at cruise load with 10% fuel reserve at rated range.

Features

1. Award winning Mercury engine
2. Premium stitched upholstery
3. Self-bailing cockpit
4. Transitional companion seat w/ sunpad lounging options





D221

LENGTH OVERALL (LOA)	21' 6"	6.5 M
WIDTH (BEAM)	8' 6"	2.6 M
MAX PEOPLE CAPACITY	11	11
MAX HORSEPOWER	250 HP	250 HP
DEADRISE	18°	18°
MAX PEOPLE WEIGHT	1,552 LBS	704 KG
FUEL CAPACITY	55 GAL	208.2 L
DRAFT DOWN	2' 9"	0.88 M
BEAM ON TRAILER	8' 6"	2.6 M



Specification dimensions are approximate and subject to variance.
Colors, graphics and some equipment shown, subject to change without notice.

Standard features

Electrical

Battery Switch
Automatic Bilge Pump

Cockpit

Standard Speakers (4)
Cup Holders (4)
Mooring Cleats (6)
Grab Handles (8)
Fuel Fill w/ Integrated Vent
Helm Seat w/ 180 Degree Swivel
In-Floor Ski/Wakeboard Storage
Waterproof 120-Watt AM/FM Stereo
w/ Bluetooth Capability

Engine

200 M MPI/ A1 (4.5 L)
ECT CARB COMPLIANT

Helm

Multi-Function Gauges w/ Fog Resistant Glass Lenses: Fuel,
Speedometer, Tachometer, Voltmeter
12V Horn
12V Accessory Outlet
Side-Mounted Engine Controls w/ Trim & Tilt Switch in Handle
Tilt Steering
Analog Trim Indicator

Hull & Deck

Bow & Transom Eyes (3)
12V Navigation Lights
Bow Ladder w/ Hinged Lid
Fiberglass Floor Liner
Swim Platform w/ Telescoping Ladder



D221

BAYLINER™

Exterior color

- Solid Black hull
- Solid Gray hull
- Solid Blue hull

- Black w/ White bottom
- Blue w/ White bottom

Interior color

- Coastline (Tan)
- Gray/White



Optional add-ons

I/O Engines

- 200 HP MerCruiser® 4.5L MPI Sterndrive (Alpha 1 Outdrive)*
- 250 HP MerCruiser® ECT 4.5L MPI Sterndrive (Alpha 1 Outdrive)
- 250 HP MerCruiser® 4.5L MPI Sterndrive (Alpha 1 Outdrive)*
- High Altitude Prop

Floor Covering

- Cockpit Flooring (Gray Mat) ★
- Cockpit Flooring (Teak Mat) ★

Lighting

- Exterior Lighting (LED Docking Lights, 2x Rear Underwater Lights)

Water Sports

- Wakeboard Rack (1)
- Wakeboard Rack (2)

Swim Platforms

- Swim Platform Mat (Gray)
- Swim Platform Mat (Teak)
- Extended Swim Platform Mat (Gray)
- Extended Swim Platform Mat (Teak)
- Swim Platform Extension
- Swim Platform Extension/Color Match/Teak
- Swim Platform Extension/Color Match/Gray

Convenience Options

- Digital Depth Indicator ★
- Full Windshield w/ Opening Control Panel
- VesselView® Mobile
- Bow Block Off (Req. Bow Filler Cushion)
- Simrad 7" Digital Dash VesselView Link
- Simrad 9" Digital Dash VesselView Link
- Transom Shower
- Portable Head
- Bow Table
- Cockpit Refrigerator

Trailer

- Galvanized T/A Trailer w/ Brakes
- Painted T/A Trailer w/ Brakes

Tower Package

Includes Standard Features plus:

- Bow Well and Cockpit Cover
- Snap-On Cover
- Stainless Steel
- Battery Switch-Dual 1/ 2nd Tray Single Engine
- ProArc Tower w/ Integrated Top
- Wireless Phone Charger

Bimini Package

Includes Standard Features plus:

- Snap-On Cover
- Stainless Steel
- Bimini Top w/ Boot
- Ski Tow Pylon
- Battery Switch-dual w/ 2nd tray single engine

Comfort Package

Includes Standard Features plus:

- Cockpit Table
- Bow Block Off (Req. Bow Filler Cushion)
- Bow Filler Cushion
- Stereo, Rockford Fosgate

Fishing Package

Includes Standard Features plus:

- Bow Casting Platform
- Aerated Live Well
- Fish Finder
- Dual Battery E/24V Plug

★ Popular option

* CANADA AND INTERNATIONAL ONLY





Engine performance data

Sterndrive

200 HP Mercury 4.5L V6 Alpha Sterndrive

Cruise mph	26.2
WOT mph	39.1
Propeller	.Black Max 15x17P
Range	149 nm
Weight as tested	5,479 lbs

250 HP Mercury 4.5L V6 Alpha Sterndrive

Cruise mph	34.4
WOT mph	42
Propeller	.Black Max 15x17P
Range	106 nm
Weight as tested	5,510lbs

This information is provided for comparison purposes and is intended to show relative performance between different boats and engine options. A specific boat's performance will be affected by water and weather conditions, altitude, condition of boat, actual load, engine and propeller. Engine performance data is based on boat in cruise load weight condition. Cruise load weight condition consists of boat with typical options, full tanks, all safety gear, two passengers and typical storage. Cruising range based on cruise speed at cruise load with 10% fuel reserve at rated range.

Features

1. Award winning Mercury engine
2. Premium upholstery
3. Deep gunnels for a safe, dry ride
4. Transitional seating creating roomy sun lounge area.





T18 Bay

LENGTH OVERALL (LOA)	18' 2"	5.5 M
WIDTH (BEAM)	7' 5"	2.3 M
MAX PEOPLE CAPACITY	6	6
MAX HORSEPOWER	115 HP	115 HP
DEADRISE	17°	17°
MAX PEOPLE WEIGHT	992 LBS	424 KG
FUEL CAPACITY	33 GAL	125 L
DRAFT DOWN	2' 7"	0.79 M
BEAM ON TRAILER	8' 6"	2.6 M

Trophy

Specification dimensions are approximate and subject to variance.
Colors, graphics and some equipment shown, subject to change without notice.

Standard features

Electrical

Battery Switch
Automatic Bilge Pump
Dual Battery w/ 24V Plug

Cockpit

Cup Holders
Mooring Cleats (6)
Grab Handles
Fuel Fill w/ Integrated Vent
Flip-Flop Cooler Seat
Self-Bailing Cockpit

Engine

90 HP Mercury® FourStroke XL EFI Outboard

Helm

Dual Purpose Gauge: Speedometer, Voltmeter
12V Accessory Outlet
12V Horn
Binnacle-Mounted Engine Controls w/ Trim & Tilt Switch in Handle
Center Console w/ Stainless Steel Steering Wheel
Mechanical Cable Steering
Analog Trim Indicator

Hull & Deck

Bow & Transom Eyes (3)
12V Navigation Lights
M-Hull Design for Added Stability
Fiberglass Floor Liner
Helm Windscreen
Integrated trolling motor mount

Trailer

Single Axle Galv Trailer



T18 Bay

Exterior color

- Solid White Hull
- Solid Black hull
- Solid Gray hull
- Solid Blue hull
- Solid Reef Green hull
- White bottom w/ Black hull
- White bottom w/ Gray hull
- White bottom w/ Blue hull
- White bottom w/ Reef Green hull

Interior color

- White

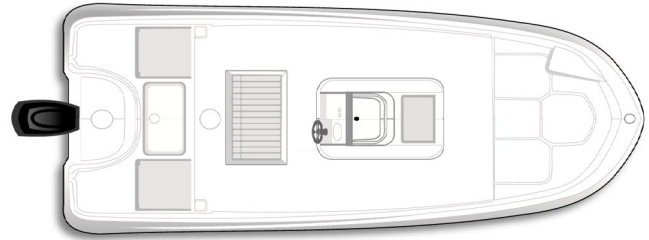

Optional add-ons

Engines

- 115 HP Mercury® FourStroke Command Thrust EFI Outboard
- 115 HP Mercury® FourStroke XL EFI Outboard
- 115 HP Mercury® Pro XS XL Outboard
- High Altitude Prop

Steering

- Hydraulic Steering System (115 HP and Below)

Tops

- K-Top
- T-Top w/ Rail-Mounted Rod Holders (4)
- Bimini, 6' Top w/ Boot ★

Canvas

- Snap-On Center Console & Helm Seat Cover ★
- Console Cover

Seats & Upholstery

- Bow Filler Cushion

Appearance Package

- Stainless Steel Package
- Trophy Logo Decal 8" Tall (in lieu of Standard)

Lighting Package

- Interior Lighting Package

Water Sports

- Wakeboard Rack (1x)
- Wakeboard Rack (2x)

Swim Platforms

- Port and Starboard Swim Boards w/ Ladder

Convenience Options

- 7" Glass Dash Screen w/ Engine Data
- Extra Wide Console
- Analog Trim Indicator
- Bow Rail
- Compass
- Digital Depth Indicator ★
- VesselView® Mobile
- Blank Dash Option
- Waterproof AM/FM Stereo w/ Bluetooth
- VHF Radio w/ Antenna

Fishing Accessories

- Bow Fishing Seat
- Fish Finder: Lowrance®
- Forward Livewell
- Trolling Motor Bracket

★ Popular option



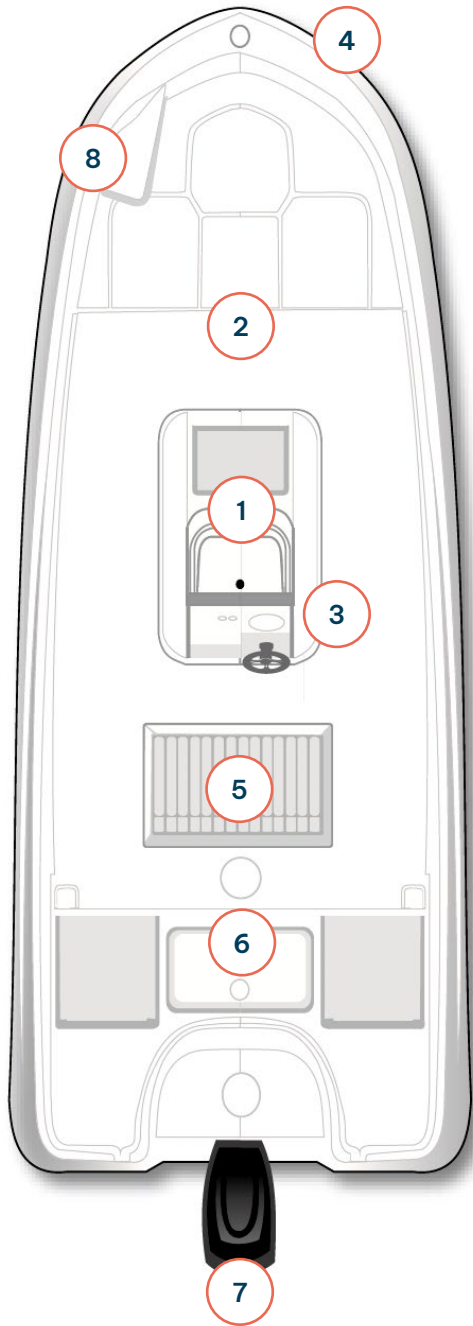

Features

1. Simple and intuitive helm controls
2. Lightweight model for easy storage, trailering and handling
3. Center Console design for all around casting ease
4. M-Hull design allows for more lateral stability when casting and shallower draft for getting in close
5. Premium stitched upholstery
6. Baitwell/Livewell
7. Award-winning Mercury® engine performance and reliability
8. Large forward casting platform with molded in trolling motor bracket





T20 CC/CX

Trophy

LENGTH OVERALL (LOA)	20' 6"	6.10 M
WIDTH (BEAM)	8' 0"	2.43 M
MAX PEOPLE CAPACITY	8	7
MAX HORSEPOWER	175 HP	200 HP
DEADRISE	18°	18°
MAX PEOPLE WEIGHT	1,323 LBS	600 KG
FUEL CAPACITY	55 GAL	208 L
DRAFT DOWN	2' 8"	0.61 M
HEIGHT ON TRAILER W/ OPTIONS	8' 11"	2.71 M
BRIDGE CLEARANCE W/ OPTIONS	7' 2"	2.19 M
BEAM	8' 0"	2.43 M
BEAM ON TRAILER	8' 6"	2.6 M
STORAGE LENGTH ¹	22' 2"	6.76 M

Specification dimensions are approximate and subject to variance.

¹ With trailer/tongue folded

Colors, graphics and some equipment shown, subject to change without notice.

Standard features

Cockpit

Self-Bailing Cockpit
Fuel Fill w/ Integrated Vent
Waterproof 120-Watt AM/FM Stereo
w/ Bluetooth Capability
Leaning Post
Battery Switch
Automatic Bilge Pump
Removable Cushions
CC Package - Flip-Up Transom Seats

Fishing

Center Console w/ Stainless Steel Steering Wheel
Leaning Post Livewell
Insulated Fish Box
Transom Aerated Livewell - CC Seating Pkg Only

Trailer

Tandem Axle Black Painted or
Galvanized Trailer w/Brakes

Engine

115 HP Mercury® FourStroke EFI Outboard

Helm

Multi-Function Gauges w/ Fog Resistant Glass Lenses: Fuel, Speedometer,
Tachometer, Voltmeter
12V Horn
Binnacle-Mounted Engine Controls w/ Trim & Tilt Switch in Handle
Tilt Steering
Mechanical Throttle and Shift

Steering

Hydraulic Steering System

Hull & Deck

Bow & Transom Eyes (3)
12V Navigation Lights
Anchor Locker
Fiberglass Floor Liner
Gunnel Rod Holders (4)
Helm Windscreen
Port and Starboard Swim Boards w/ Ladder



T20CC/CX

BAYLINER™

Exterior color

- Solid White Hull
- Solid Black hull
- Solid Gray hull
- Solid Blue hull
- Solid Reef Green hull
- White bottom w Black hull
- White bottom w Gray hull
- White bottom w Blue hull
- White bottom w Reef Green hull

Interior color

- Graphite (Gray)
- Coastline (Tan)

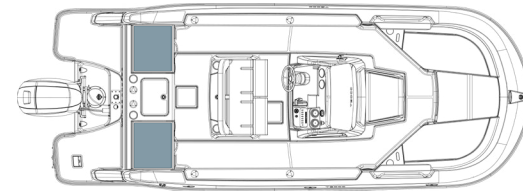

CC
Flip-Up Transom Seats

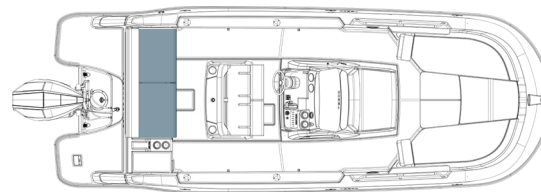

CX
Transom Cruising Bench Seat

Optional add-ons

Engines

- 115 HP 4-Stroke EFI Command Thrust Mercury® Outboard
- 115 HP Mercury® Pro XS XL Outboard
- 150 HP Mercury® FourStroke EFI Outboard
- 175 HP Mercury® Fourstroke ProXS Outboard
- Pre-Rig, Blank V6 Mercury DTS
- Blank, Mercury Outboard 135HP and Higher
- High Altitude Prop

Steering

- Power Steering – 175 HP and higher, OB

Tops

- T-Top w/ Rail-Mounted Rod Holders (4)
- Bimini, 6' Top w/ Boot ★

Canvas

- Snap-On Center Console & Helm Seat Cover ★

Floor Covering

- Cockpit Flooring (Gray Mat) ★
- Cockpit Flooring (Teak Mat) ★

Seats & Upholstery

- CC Package - Flip-Up Transom Seats
- CX Package - Transom Cruising Bench Seat
- Bow Filler Cushion

Fishing Accessories

- Dual Battery Trays w/ 24V Plug

Appearance Package

- Stainless Package (Fuel Fill, Thru Hull, Horn Vent, Bow Hatch, Latches, Rub Rail)
- Large Trophy Decal Set

Lighting

- Exterior Lighting (LED Docking Lights, 2x Rear Underwater Lights)
- Interior Lighting

Water Sports

- Ski Tow Pylon

Convenience Options

- 7" Glass Dash Screen w/ Engine Data*
- 9" Glass Dash Screen w/ Engine Data*
- Twin Simrad 7" Digital Dashes with VesselView® Link
- Twin Simrad 9" Digital Dashes with VesselView® Link
- Transom Shower w/ On-Demand Water System
- Cockpit Table
- Digital Depth Indicator ★
- VesselView® Mobile
- Rockford Fosgate® Stereo System
- Anchor Roller
- Dual Battery Trays w/ Switch
- Raw Water Washdown

★ Popular option

* Glass Dash options available in dual screen configurations



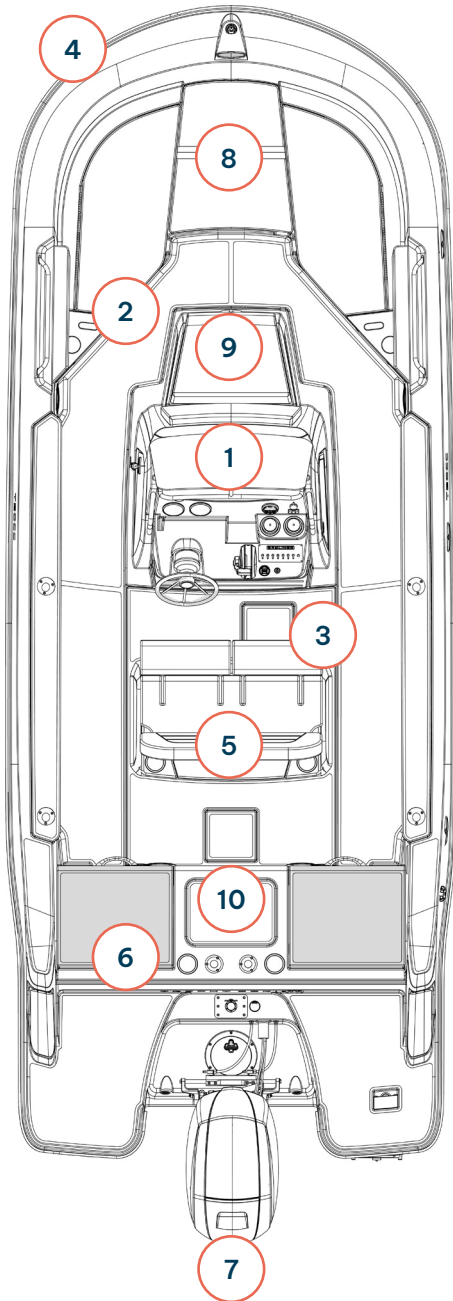

Features

1. Simple and intuitive helm controls
2. Lightweight model for easy storage, trailering and handling
3. Center console design for all around casting ease
4. V-Hull allows for a smooth ride with higher speed and a dryer ride
5. Premium stitched upholstery
6. Molded-in storage and cup holders
7. Award-winning Mercury® engine performance and reliability
8. Filler cushion turns bow into a sun lounger
9. Built-in forward console storage
10. Integrated livewell/baitwell (CC Package only)





T22 CC/CX

LENGTH OVERALL (LOA)	22' 7"	6.88 M
WIDTH (BEAM)	8' 6"	2.6 M
MAX PEOPLE CAPACITY	10	8
MAX HORSEPOWER	300 HP	300 HP
DEADRISE	18°	18°
MAX PEOPLE WEIGHT	1,654 LBS	750 KG
FUEL CAPACITY	65 GAL	246 L
DRAFT DOWN	3' 1"	0.93 M
BEAM ON TRAILER	8' 6"	2.6 M

Trophy

Specification dimensions are approximate and subject to variance.

¹ Tongue jack lowered all the way down.

² Stern drive in down position and trailer tongue swung to side.

Colors, graphics and some equipment shown, subject to change without notice.

Standard features

Electrical

Battery switch
Automatic Bilge Pump

Cockpit

Self-Bailing Cockpit
Fuel Fill w/ Integrated Vent
Waterproof 120-Watt AM/FM Stereo w/
Bluetooth Capability
Leaning Post
Removable Cushions
CC Package - Flip-Up Transom Seats

Fishing

Center Console w/ Stainless Steel Steering
Wheel
Leaning Post w/ Livewell
Aerated Livewell, CC
Insulated Fish Box

Engine

150 HP Mercury® FourStroke EFI Outboard

Helm

Multi-Function Gauges w/ Fog Resistant Glass Lenses: Fuel, Speedometer,
Tachometer, Voltmeter
12V Horn
Binnacle-Mounted Engine Controls w/ Trim & Tilt Switch in Handle
Tilt Steering
Mechanical Throttle and Shift

Hull & Deck

Bow & Transom Eyes (3)
12V Navigation Lights
Anchor Locker
Fiberglass Floor Liner
Gunnel Rod Holders (4)
Helm Windscreen
Port and Starboard Swim Boards w/ Ladder

Trailer

Tandem Axle Painted or Galvanized Trailer w/Brakes



T22CC/CX

Exterior color

- Solid White Hull
- Solid Black hull
- Solid Gray hull
- Solid Blue hull
- Solid Reef Green hull
- White bottom w/ Black hull
- White bottom w/ Gray hull
- White bottom w/ Blue hull
- White bottom w/ Reef Green hull

Interior color

- Graphite (Gray)
- Coastline (Tan)

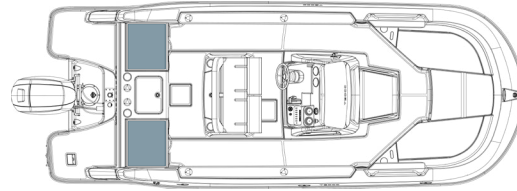

CC
Flip-Up Transom Seats

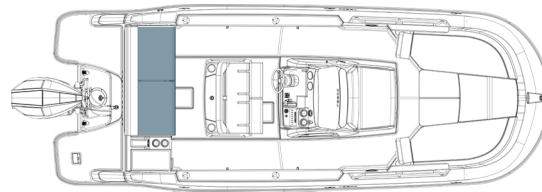

CX
Transom Cruising Bench Seat

Optional add-ons

OB Engines

- 175 HP Mercury® Fourstroke ProXS Outboard
- 200 HP Mercury® FourStroke Outboard Non-DTS (Black)
- 250 HP Black Mercury® OB Non-DTS (Black)
- 300 HP Black Mercury® Verado® OB
- High Altitude Prop
- Pre-rig for V6 Mercury® DTS
- Pre-rig, Blank V8 Mercury® DTS
- Warm Fusion White Options Available as Applicable

Steering

- Power Steering – 175 HP and higher

Tops

- T-Top w/ Rail-Mounted Rod Holders (4)
- Bimini, 6' Top w/ Boot ★

Canvas

- Snap-On Center Console & Helm Seat Cover ★

Floor Covering

- Cockpit Flooring (Gray Mat) ★
- Cockpit Flooring (Teak Mat) ★

Seats & Upholstery

- CC Package - Flip-Up Transom Seats
- CX Package - Transom Cruising Bench Seat
- Bow Filler Cushion

Fishing Accessories

- Dual Battery Trays w/ 24V Plug

Appearance Package

- Stainless Package (Fuel Fill, Thru Hull, Horn Vent, Bow Hatch, Latches, Rub Rail)
- Large Trophy Decal Set

Lighting Package

- Exterior Lighting (LED Docking Lights, 2x Rear Underwater Lights)
- Interior Lighting Package

Water Sports

- Ski Tow Pylon

Convenience Options

- 7" Glass Dash Screen w/ Engine Data*
- 9" Glass Dash Screen w/ Engine Data*
- Twin Simrad 7" Digital Dashes with VesselView® Link
- Twin Simrad 9" Digital Dashes with VesselView® Link
- Transom Shower w/ On-Demand Water System
- Bilge Pump (Automatic) ★
- Cockpit Table
- Digital Depth Indicator ★
- Portable Head
- VesselView® Mobile
- Raw Water Washdown
- Anchor Roller
- Dual Battery Trays w/ Switch
- Rockford Fosgate® Stereo Upgrade
- Leaning Post

★ Popular option

* Glass Dash options available in dual screen configurations



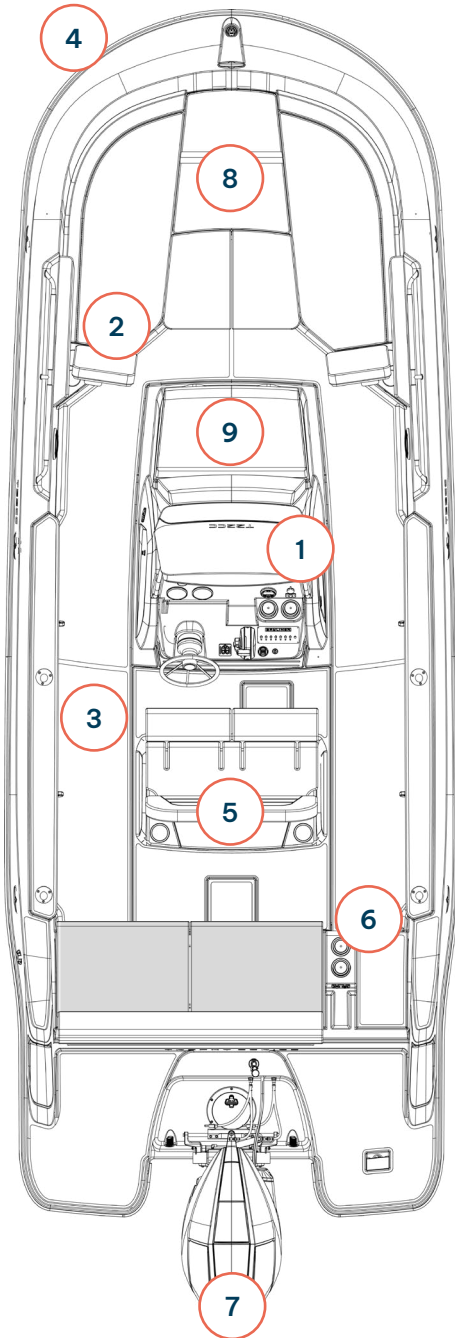

Features

1. Simple and intuitive helm controls
2. Lightweight model for easy storage, trailering and handling
3. Center console design for all around fishing ease
4. V-Hull allows for a smooth ride with higher speed and near shore performance
5. Premium stitched upholstery
6. Molded-in storage and cup holders
7. Award-winning Mercury® engine performance and reliability
8. Filler cushion turns bow into a sun lounger
9. Built-in forward console storage





T24CC

LENGTH OVERALL (LOA)	24' 7"	7.49 M
WIDTH (BEAM)	8' 6"	2.6 M
MAX PEOPLE CAPACITY	12	12
MAX HORSEPOWER	300 HP	300 HP
DEADRISE	22°	22°
APPROX WEIGHT W/ STANDARD ENGINE	4,466 LBS	2,026 KG
APPROX WEIGHT W/ TRAILER	6,115 LBS	2,774 KG
MAX PEOPLE WEIGHT	1,984 LBS	900 KG
FUEL CAPACITY	100 GAL	378.5 L
DRAFT DOWN	2' 11"	0.89 M
STORAGE HEIGHT ¹	11' 2"	3.4 M
BEAM ON TRAILER	8' 6"	2.6 M
STORAGE LENGTH ²	32' 10"	10.0 M

Trophy

Specification dimensions are approximate and subject to variance.

¹ With trailer/tower folded

² Outboard motor in down position and trailer tongue swung to side.

Colors, graphics and some equipment shown, subject to change without notice.

Standard features

Steering

Hydraulic Steering System

Cockpit

Self-Bailing Cockpit
Raw Water Washdown
Fuel Fill w/ Integrated Vent
Waterproof 120-Watt AM/FM Stereo
w/ Bluetooth® Capability
Leaning Post w/ Livewell
Dual Batteries w/ Switch
Automatic Bilge Pump
Removable Bow Backrests and Cushions
Fold-Away Rear Bench Seat
Canvas T-Top w/ Rod Holders (4)
CC Fishing Seats w/ Livewell

Fishing

Center Console w/ Stainless Steel Steering Wheel
15-Gal Baitwell
21-Gal Leaning Post Livewell
6-Ft Dual Insulated Fish Boxes
Under Gunnel Rod Storage
Gunnel Rod Holders (4)

Engine

225 XXL Fourstroke OB Non-DTS (Black)

Helm

Multi-Function Gauges w/ Fog-Resistant Glass Lenses: Fuel,
Speedometer, Tachometer, Voltmeter
12V Horn
Binnacle-Mounted Engine Controls w/ Trim & Tilt Switch in Handle
Tilt Steering
Mechanical Throttle & Shift
Console Storage

Hull & Deck

Bow & Transom Eyes (3)
12V Navigation Lights
Anchor Locker
Fiberglass Floor Liner
Helm Windshield
Port and Starboard Swim Boards w/ Ladder
Stainless Steel Cleats (6)
Trim Tabs



T24CC

BAYLINER

Exterior color

- Solid White Hull
- Solid Black hull
- Solid Gray hull
- Solid Blue hull
- Solid Reef Green hull
- White bottom w/ Black hull
- White bottom w/ Gray hull
- White bottom w/ Blue hull
- White bottom w/ Reef Green hull

Interior color

- Graphite (Gray)
- Coastline (Tan)

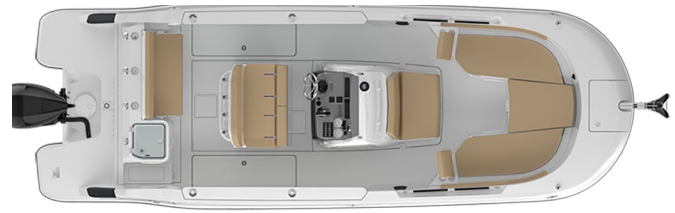

Optional add-ons

OB Engines

- 250 HP XXL Mercury® FourStroke Outboard Non-DTS
- 300 HP XXL Mercury® V8 AMS Outboard (Includes Power-Assisted Steering)
- High Altitude Prop
- Pre-Rig Blank V6 Mercury® DTS
- Pre-Rig Blank V8 Mercury® DTS For 250 HP
- Pre-Rig Blank V8 Mercury® DTS For 300 HP
- Warm Fusion White Options Available as Applicable

Steering

- Power Steering – 175 HP & Higher (Outboard Only)
- Power Steering – 300 HP AMS
- Premium Steering Wheel w/ Knob ★

Tops

- Fiberglass Hardtop w/ Spreader Lights

Canvas

- Snap-On Center Console & Helm Seat Cover ★

Floor Covering

- Cockpit Flooring (Gray Mat) ★
- Cockpit Flooring (Teak Mat) ★

Seats & Upholstery

- Bow Filler Cushion
- Premium Leaning Post w/ Bolsters (Premium Helm Seat w/ Fold up Bolsters, Integrated Livewell And Clear Acrylic Livewell Lid)
- Leaning Post (Base Leaning Post minus Livewell and Seat Bolsters)

Fishing Accessories

- Trolling Motor Bracket w/ 24V Plug
- Trolling Motor Pre-Rig w/ 24V Plug

Water Sport

- Ski Tow Pylon

Appearance Package

- Stainless Package (Fuel Fill, Thru Hull, Horn Vent, Bow Hatch, Latches, Rub Rail) ★
- Large Trophy Decal Set
- 6" Forward, Mid & Aft Pop Up Cleats

Lighting

- Exterior Lighting (LED Docking Lights, 2x Rear Underwater Lights)
- Interior Lighting

Convenience Options

- Simrad 9" Digital Dash* with VesselView® Link
- Twin Simrad 9" Digital Dashes with VesselView® Link
- Cockpit Table
- Digital Depth Indicator ★
- Portable Head
- Freshwater Shower (10-Gal Tank)
- VesselView® Mobile
- Anchor Roller
- Windlass
- Dual Battery Trays w/ Switch ★
- 25-qt Carry-On Cooler
- Rockford Fosgate® System (4 Speaker)
- VHF Radio w/ Antenna
- Blank Dash Option
- CX Package – Transom Cruising Bench Seat
- SmartCraft SC1000 Gauge (Speed & Tach)
- Dual Fishwell Macerator Pumps

Trailer

- Tandem Axle Aluminum Trailer w/ Brakes & Swing Tongue

★ Popular option

* 9" Digital Dash Available in Twin Configuration





Features

1. Simple and intuitive helm controls w/ molded in cupholders and chuck storage
2. Center console design for ease of casting and fishing
3. Deep V-Hull allows for a smooth and dry ride in deeper waters
4. Premium stitched upholstery
5. Molded-in storage and cup holders
6. Award-winning Mercury® engine performance and reliability
7. Filler cushion turns bow into a sun lounger
8. Built-in livewell in standard CC configuration
9. Large in-floor fish lockers
10. Built-in forward console storage





T22SC

LENGTH OVERALL (LOA)	22' 7"	7.3 M
WIDTH (BEAM)	8' 6"	2.6 M
MAX PEOPLE CAPACITY	10	10
MAX HORSEPOWER	250 HP	250 HP
DEADRISE	18°	18°
APPROX WEIGHT W/ STANDARD ENGINE	4,500 LBS	2,041.2 KG
MAX PEOPLE WEIGHT	1,650 LBS	748.4 KG
FUEL CAPACITY	80 GAL	302.8 L
DRAFT DOWN	2' 9"	0.88 M
STORAGE HEIGHT ¹	6' 4"	1.9 M
BEAM ON TRAILER	8' 6"	2.6 M
LENGTH W/ TRAILER	24'	7.3 M

Trophy

Specification dimensions are approximate and subject to variance.

¹ With trailer/tower folded

Colors, graphics and some equipment shown, subject to change without notice.

Standard features

Electrical

Battery Switch
Automatic Bilge Pump

Cockpit

Self-Bailing Cockpit
Fuel-Fill w/ Intergrated Vent
Waterproof 120-Watt AM/FM Stereo w/Bluetooth
Removeable Cushions
Forward Console Bench Seating w/ backrest
Cupholders (8)
Side Console Storage

Fishing

Livewell
Gunnel Rod Storage
Insulated Fish Box

Engine

150 HP EFI 4 Stroke Mercury OB

Helm

Multi-Function Gauges w/ Fog Resistant Glass Lenses: Fuel, Speedometer, Tachometer, Voltmeter
12V Horn
Helm Windshield
Stainless Steel Steering Wheel

Hull & Deck

Swim Platform w/ Telescoping Ladder
Anchor Locker
Fiberglass Floor Liner
Bow & Transom Eyes (3)
Navigation Lights

Trailer

Galvanized Trailer w/ Brakes

T22SC

BAYLINER

Exterior color

- White bottom w/ Black hull
- White bottom w/ Gray hull
- White bottom w/ Blue hull

Interior color

- Graphite (Gray)
- Coastline (Tan)



Optional add-ons

OB Engines

- 200 HP Mercury FourStroke Outboard Warm Fusion White Non-DTS
- 250 HP Mercury FourStroke Black Non-DTS
- 250 HP Mercury FourStroke Outboard Warm Fusion Non-DTS
- 225 XXL Fourstroke OB Non-DTS (Black)
- High Altitude Prop

Canvas

- Snap-On Center Console & Helm Seat Cover ★

Floor Covering

- Cockpit Flooring (Gray Mat) ★
- Cockpit Flooring (Teak Mat) ★

Lighting

- Exterior Lighting (LED Docking Lights, 2x Rear Underwater Lights)
- Interior Lighting

Trailer

- Tandem Axle Aluminum Trailer w/ Brakes & Swing Tongue

Convenience Options

- Digital Depth Indicator
- Simrad 7" Digital Dash w/ VesselView® Link
- Simrad 9" Digital Dash w/ VesselView Link
- Bow Well and Cockpit Cover

Fishing Package

Includes Standard Features plus:

- Trolling Motor Bracket w/ 24V Plug
- Fresh Water Washdown
- Steering Wheel w/ Knob
- Bow Casting Seat

Bimini

Includes Standard Features plus:

- Stainless Steel Upgrade
- Bimini Top w/ Boot
- Windshield Wiper (Starboard)

Comfort Package

Includes Standard Features plus:

- Cockpit Table
- Bow Block Off (Req. Bow Filler Cushion)
- Bow Filler Cushion
- Portable Head

Tech Package

Includes Standard Features plus:

- Exterior Lighting Package
- VesselView® Mobile
- Stereo, Rockford Fosgate
- Interior Lighting Package
- Dual Vessel Batteries w/ Switch

★ Popular option

* 9" Digital Dash Available in Twin Configuration

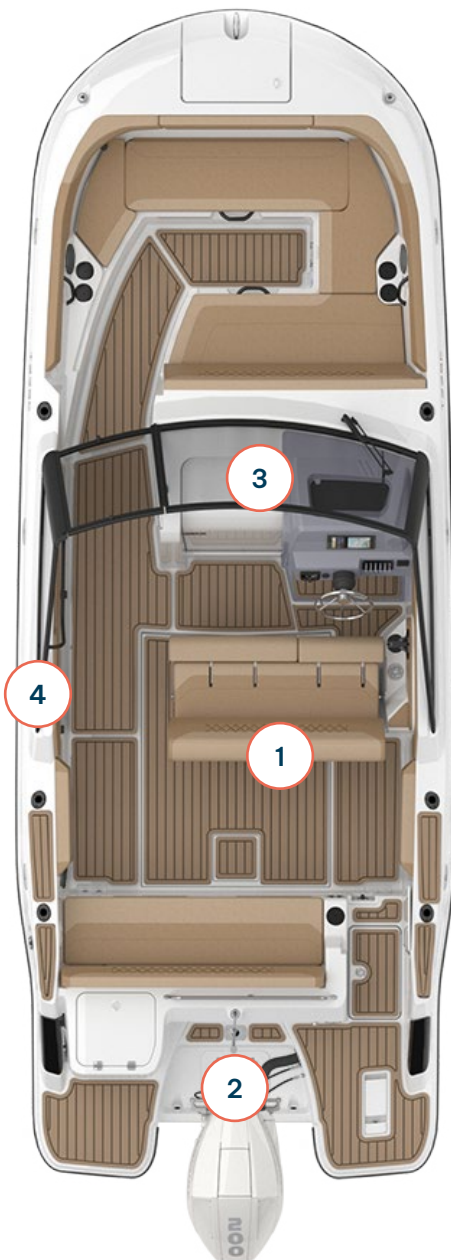

Engine performance data

Outboard

150 HP Mercury FS XL Outboard

Cruise mph	27.3
WOT mph	36
Propeller	Enertia 15.3x14P
Range	206 nm
Weight as tested	5,464 lbs

200 HP Mercury V6 FS XL Outboard

Cruise mph	30.7
WOT mph	39.6
Propeller	Enertia 15x15P
Range	227 nm
Weight as tested	5,594 lbs

250 HP Mercury V8 FS XL Outboard

Cruise mph	31.7
WOT mph	44.3
Propeller	Enertia 15x15P
Range	191 nm
Weight as tested	5,624 lbs

This information is provided for comparison purposes and is intended to show relative performance between different boats and engine options. A specific boat's performance will be affected by water and weather conditions, altitude, condition of boat, actual load, engine and propeller. Engine performance data is based on boat in cruise load weight condition. Cruise load weight condition consists of boat with typical options, full tanks, all safety gear, two passengers and typical storage. Cruising range based on cruise speed at cruise load with 10% fuel reserve at rated range.

Features

1. Premium Forward Console Bench Seating
2. Award Winning Mercury Engine
3. Console Storage
4. Gunnel Rod Storage



T23 Explorer

LENGTH OVERALL (LOA)	24'2"	7.37 M
WIDTH (BEAM)	8'4"	2.54 M
MAX PEOPLE CAPACITY	9	9
MAX HORSEPOWER	225 HP	225 HP
DEADRISE	16°	16°
APPROX WEIGHT W/ STANDARD ENGINE	4,075 LBS	1,848 KG
MAX LOAD WEIGHT	2,350 LBS	1,066 KG
FUEL CAPACITY	53 GAL	200 L
WATER CAPACITY	11.8 GAL	45 L
DRAFT DOWN	3'	.91 M
HEIGHT ¹	9'2"	2.79 M
HEIGHT ¹ W/ OPTIONS	9'5"	2.87 M

Specification dimensions are approximate and subject to variance.

¹ With trailer/tower folded

² Outboard motor in down position and trailer tongue swung to side.

Colors, graphics and some equipment shown, subject to change without notice.

Trophy

Standard features

Cockpit

- Cockpit Sun Lounge
- Aft Bench Seat
- Storage below Aft Seat
- Aft Seat Extension L-Lounge
- Cockpit Cushions
- Real teak cockpit table
- Cockpit Shower
- Transom Door

Equipment

- Stereo Fusion with 4 speakers
- VesselView Mobile
- Active Trim
- Dual Battery System
- CO Monitor
- Smoke Detector
- Electric & Manual Bilge Pump
- Starboard Windshield Wiper
- Windshield Wash
- OB Pre-Rigging
- Bimini with Enclosed Canvas

Engine

150HP Mercury FourStroke EFI Outboard

Steering

Hydraulic Steering System

Helm

SmartCraft Speedometer/
Tachometer
12v Electrical Socket

Hull & Deck

Bow Roller
Swim Ladder
Navigation Lights
Forward Line/Anchor Locker
Self Bailing Cockpit
Rod holders
Swim Platforms
Swim Platform Extensions
Hull Color (White)
LED Courtesy lights

Cabin

Storage below Berth
Pilot Seats with Flip Bolster and Swivel
Dinette Seat Configuration
Berth Cushion/Filler
Deck Hatch



T23 Explorer

 BAYLINER



Optional add-ons

Engines

- Mercury 225 V6

Cabin Comfort Pack

- Enclosed sea toilet with sink
- Curtains
- Refrigerator 51L

Floor Covering

- Flexiteek Flooring

Convenience Options

- Simrad GPS/Chart Plotter 9" NSS evo3s with HDI Transducer & VesselView Link Digital Interface
- Simrad VHF RS20
- Bow Thruster
- Diesel Heating
- Bow Electrical Windlass
- Wallas stove
- Roof Hatch
- Forward Sun Lounge

Features

1. Award winning Mercury engine
2. Premium stitched upholstery
3. Enclosed cabin
4. Galley sink w/ tap
5. Foredeck w/ opening hatch
6. Sliding cabin entry door
7. Versatile cockpit area





T25 Explorer

LENGTH OVERALL (LOA)	25'6"	7.76 M
WIDTH (BEAM)	9'4"	2.84 M
MAX PEOPLE CAPACITY	11	11
MAX HORSEPOWER	300 HP	300 HP
DEADRISE	17°	17°
APPROX WEIGHT W/ STANDARD ENGINE	5,189 LBS	2,354 KG
MAX LOAD WEIGHT	2,650 LBS	1,020 KG
FUEL CAPACITY	74 GAL	280 L
WATER CAPACITY	21.1 GAL	79 L
DRAFT DOWN	3'1"	.52 M
HEIGHT ¹	9'8"	2.94 M
HEIGHT ¹ W/ OPTIONS	10"10'	3.30 M

Specification dimensions are approximate and subject to variance.

¹ With trailer/tower folded

² Outboard motor in down position and trailer tongue swung to side.

Colors, graphics and some equipment shown, subject to change without notice.

Trophy

Standard features

Cockpit

- Cockpit Sun Lounge
- Aft Bench Seat
- Storage below Aft Seat
- Aft Seat Extension L-Lounge
- Cockpit Cushions
- Cockpit Shower
- Transom Door
- Upgraded Cockpit Table
- Cockpit Lighting

Equipment

- Shore Power
- Stereo Fusion with 6 speakers
- VesselView Mobile
- Active Trim
- Bow Thruster
- City Water Inlet
- Dual Battery System
- CO Monitor
- Smoke Detector
- Electric & Manual Bilge Pump
- Electric Trim Tabs
- Starboard Windshield Wiper
- Port Windshield Wiper
- Windshield Wash
- OB Pre-Rigging
- Bimini with Enclosed Canvas

Engine

- Mercury 225 V6

Steering

- Hydraulic Steering System
- Power Steering

Helm

- SmartCraft Speedometer/
Tachometer
- 12v Electrical Socket
- Adjustable Steering Position

Hull & Deck

- Bow Roller
- Swim Ladder
- Navigation Lights
- Forward Line/Anchor Locker
- Self Bailing Cockpit
- Rod holders
- Swim Platforms
- Swim Platform Extensions
- Hull Color (White)
- LED Courtesy lights
- Hull side windows

Cabin

- Berth (4)
- Storage below Berth
- Pilot Seats with Flip Bolster and Swivel
- Dinette Seat Configuration
- Berth Cushion/Filler
- Deck Hatch
- Opening Portlights
- Sink with Tap
- Enclosed Sea toilet
- Opening Portlight



T25 Explorer



Optional add-ons

Engines

- Mercury 300 V8 Verado

Cabin Comfort Pack

- Refrigerator 51L
- Hardtop Roof hatch
- Foredeck & Hardtop Hatch Cover (roller surface: blackout/flyscreen)
- Upper and lower cabin curtains

Floor Covering

- Flexiteek Flooring

Seats & Upholstery

- Aft Seat Folding Backrest

Convenience Options

- Simrad GPS/Chart Plotter 9"NSS evo3s with HDI Transducer & VesselView Link Digital Interface
- Simrad VHF RS20
- Bow Thruster
- Diesel Heating
- Bow Electrical Windlass
- Wallas stove
- Forward Sun Lounge
- Single air conditioning/heating with battery bank

Features

1. Award winning Mercury engine
2. Premium stitched upholstery
3. Spacious dining area
4. Adjustable steering position
5. Transom door
6. Additional storage below aft seat
7. Aft seat extension L-lounge





T29 Explorer

Trophy

LENGTH OVERALL (LOA)	29'10"	9.09 M
WIDTH (BEAM)	9'9"	2.97 M
MAX HORSEPOWER	450 HP	450 HP
DEADRISE	17°	17°
APPROX WEIGHT W/ STANDARD ENGINE	6,508 LBS	2,951 KG
FUEL CAPACITY	126 GAL	476 L
WATER CAPACITY	26.4 GAL	100 L
DRAFT DOWN	3'7"	1.14 M
HEIGHT ¹	11'4"	3.45 M
HEIGHT ¹ W/ OPTIONS	12'3"	3.73 M

Specification dimensions are approximate and subject to variance.

¹ With trailer/tower folded

² Outboard motor in down position and trailer tongue swung to side.

Colors, graphics and some equipment shown, subject to change without notice.

Standard features

Cockpit

Cockpit Sun Lounge
Aft Bench Seat
Aft Seat Folding Backrest
Storage below Aft Seat
Aft Seat Extension L-Lounge
Cockpit Cushions
Transom Door
Upgraded Cockpit Table

Equipment

Shore Power
Stereo Fusion with 6 speakers
Simrad GPS/Chart Plotter 9" NSS
evo3s with HDI Transducer &
VesselView Link Digital Interface
VesselView Mobile
Active Trim
Bow Thruster
City Water Inlet
Dual Battery System
CO Monitor
Smoke Detector
Electric & Manual Bilge Pump
Electric Trim Tabs
Starboard Windshield Wiper
Port Windshield Wiper

Windshield Wash
OB Pre-Rigging
Spotlight
Bimini with Enclosed Canvas
Interior TV bracket
Rooftop Hatch

Engine

2x Mercury 225 V6

Steering

Hydraulic Steering System

Helm

SmartCraft Speedometer/
Tachometer
12v Electrical Socket

Hull & Deck

Bow Roller
Swim Ladder
Navigation Lights
Forward Line/Anchor Locker
Self Bailing Cockpit
Rod Holders

Swim Platforms
Swim Platform Extensions
Hull Color (White)
LED Courtesy Lights
Hull Side Windows
Bow Electrical Windlass

Cabin

Berth (5)
Storage below Berth
Pilot Seats with Flip Bolster
and Swivel
Dinette Seat Configuration
Berth Cushion/Filler
Deck Hatch
Opening Portlights
Shower
Sink with Tap
Enclosed Sea toilet
Opening Portlight
Roof Hatch
Hatch Screen Cover
Microwave prerig only



T29 Explorer



Optional add-ons

Cabin Comfort Pack

- Curtains
- Refrigerator 51L
- Interior floor carpet

Floor Covering

- Flexiteek Flooring

Lighting

- Cockpit Lighting

Convenience Options

- Simrad VHF RS20
- Simrad HALO20 Radar
- Bow Thruster
- Diesel Heating
- Wallas stove
- Forward Sun Lounge
- Single air conditioning/heating with battery bank
- Cockpit Shower

Features

1. Award winning Mercury engine
2. Premium stitched upholstery
3. Yacht Certified
4. Spacious Dinette Seat Configuration
5. Sliding aft seat
6. Seat extension L-lounge
7. Sliding side entry door
8. Galley





T23 Pilothouse

LENGTH OVERALL (LOA)	23' 7"	7.18 M
WIDTH (BEAM)	8' 6"	2.6 M
MAX PEOPLE CAPACITY	9	9
MAX HORSEPOWER	225 HP	225 HP
DEADRISE	17°	17°
APPROX WEIGHT W/ STANDARD ENGINE	4,071 LBS	1,846 KG
MAX PEOPLE WEIGHT	1,500 LBS	680 KG
FUEL CAPACITY	51 GAL	193 L
DRAFT DOWN	3'	.49 M
HEIGHT1	9'2"	2.79 M
HEIGHT1 W/ OPTIONS	10'5"	3.17 M

Specification dimensions are approximate and subject to variance.

¹ With trailer/tower folded

² Outboard motor in down position and trailer tongue swung to side.

Colors, graphics and some equipment shown, subject to change without notice.

Trophy

Standard features

Cockpit

Cockpit Rod Storage
Rod holders
Self Bailing Cockpit
Transom Door
Cockpit Flood Light

Equipment

CO Monitor
VesselView Mobile
Active Trim
Smoke Detector
Electric & Manual Bilge Pump
Starboard Windshield Wiper
OB Pre-Rigging
Dual Battery System

Engine

Mercury 175 V6

Steering

Hydraulic Steering
Tilt Steering

Helm

Smartcraft Speedometer/Tachometer
12v Electrical Socket

Hull & Deck

Swim Ladder
Swim Platform
Anchor Locker
Navigation Lights

Cabin

Storage below Berth
Cabin Lights
Pilot & Co-pilot Seat
Starboard Pilothouse Entry Door
Portside Pilothouse Entry Door

Seats & Upholstery

Aft Flip Seats & Table
Bow Cushion

USA Premium Package

Black Bow Railing with Fender Holders
Swim Platform Extension
Bow Roller
Rocket Launcher Rod Holders & Black Roof Rack
Cockpit Shower
Roof Hatch
Sink with Tap
Stereo Fusion with 4 speakers



T23 Pilothouse

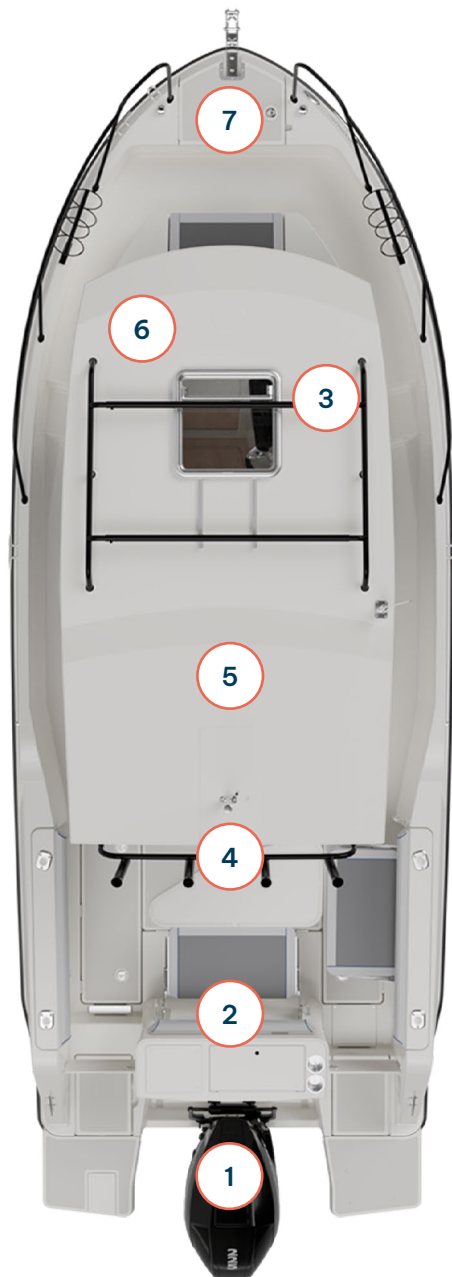

Optional add-ons

OB Engines

- Mercury 225 V6

Cabin Comfort Pack

- Berth Filler/Cushions
- Interior Curtains
- Starboard passenger flip seat
- Sea Toilet with front Portlight & Cabin door

Fish Pack

- Port & Starboard Fish Locker with Pumpout
- Extra Rod holders (2)
- Raw Water Washdown with Faucet
- Port & Starboard Toe Rails
- Fish Station Gunnel Pad
- Fishing Station with Livewell System

Convenience Options

- Hardtop Spotlight
- VHF Simrad
- GPS 9" Simrad NSS evo3s with Mercury VesselView
- Starboard and Aft Flip Seats
- Cockpit Table
- Bow Electrical Windlass
- Bow Thruster
- Bow Cushion
- Refrigerator

Features

1. Award winning Mercury engine
2. Premium stitched upholstery
3. Pilot & Co-Pilot Seat
4. Ample Rod Storage
5. Spacious fishing cockpit that doubles as dining area
6. Large berth
7. Anchor locker and windlass





T25 Pilothouse

LENGTH OVERALL (LOA)	25' 4"	7.72 M
WIDTH (BEAM)	9' 6"	2.89 M
MAX PEOPLE CAPACITY	10	10
MAX HORSEPOWER	350 HP	350 HP
DEADRISE	17°	17°
APPROX WEIGHT W/ STANDARD ENGINE	5,367 LBS	2,653 KG
MAX PEOPLE WEIGHT	1,650 LBS	1,202 KG
FUEL CAPACITY	86 GAL	325 L
DRAFT DOWN	3' 7"	1.09 M
HEIGHT1	9'8"	2.94 M
HEIGHT1 W/ OPTIONS	10'10"	3.30 M

Trophy

Specification dimensions are approximate and subject to variance.

¹ With trailer/tower folded

² Outboard motor in down position and trailer tongue swung to side.

Colors, graphics and some equipment shown, subject to change without notice.

Standard features

Cockpit

Cockpit Rod Storage
Rod holders
Self Bailing Cockpit
Transom Door
Cockpit Flood Light
Electric & Manual Bilge Pump

Equipment

VesselView Mobile
Active Trim
Dual Battery System
CO Monitor
Smoke Detector
Electric & Manual Bilge Pump
Starboard Windshield Wiper
OB Pre-Rigging

Engine

Mercury 225 V6

Steering

Hydraulic Steering
Tilt Steering

Helm

Smartcraft Speedometer/
Tachometer
12v electrical socket

Hull & Deck

Swim Ladder
Swim Platform
Anchor Locker
Navigation Lights

Cabin

Storage below Berth
Cabin Lights
Pilot & Co-pilot Seat
Starboard Pilothouse Entry Door

USA Premium Package

Bow Roller
Roof Hatch
Stereo Fusion with 4 speakers
Port & Starboard Fish Locker
with Pumpout
Raw Water Washdown with Faucet
Port & Starboard Toe Rails
Fish Station Gunnel Pad
Fishing Station with Livewell System
Interior Rod Racks
Sink with Tap
Enclosed Sea toilet
Opening Portlight
Windshield Wash
Shore Power

Simrad GPS/Chart Plotter 7" NSS evo3
with HDI Transducer -
Mounted in Cabin
VesselView Link digital interface
Bow Thruster
Bow Electrical Windlass
Hardtop Spotlight



T25 Pilothouse

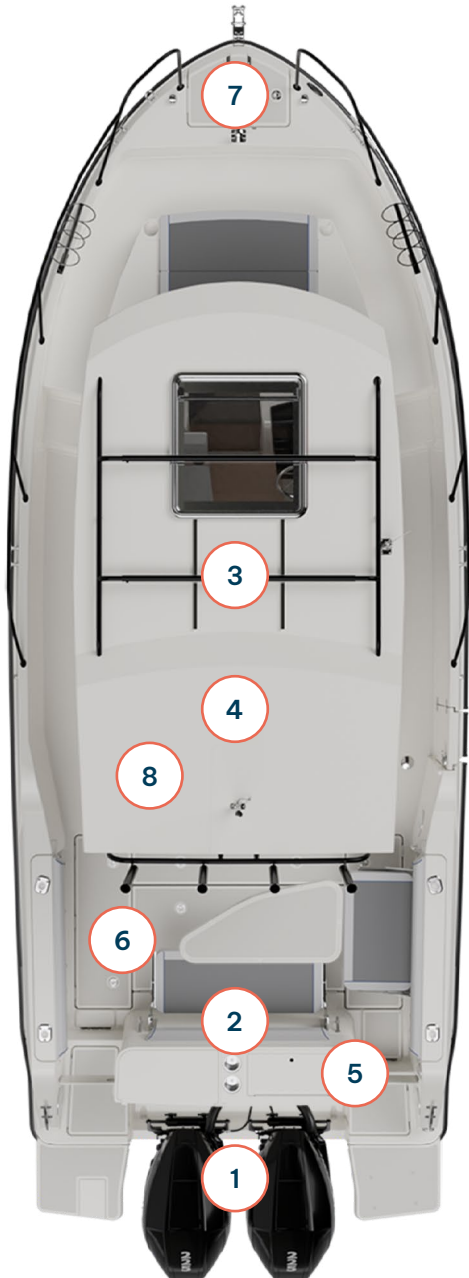

Optional add-ons

OB Engines

- Mercury Dual Helm 225 V6

Comfort Pack

- LED Courtesy Lights
- Cockpit Shower
- Aft Flip Down Seat
- Starboard Flip Down Seat
- Cockpit Table
- Berth Filler/Cushions
- Interior Curtains
- Refrigerator

Convenience Options

- Radar Simrad Halo 20 Dome
- VHF Simrad
- Bow Mooring Bollard
- Zipwake Dynamic Trim-Control System
- Exterior Cockpit GPS 7" Simrad NSS evo3 (Single Helm Rigging)
- Exterior Cockpit GPS 7" Simrad NSS evo3 (Dual Helm Rigging)
- Explorer rails

Features

1. Award winning Mercury engine
2. Premium stitched upholstery
3. Free-Flowing Cabin
4. Spacious fishing cockpit that doubles as a dining area
5. Fishing livewell system
6. Large fish lockers
7. Anchor locker and windlass
8. Galley





BAYLINER.COM   