



 BAYLINER™

# Product Information Guide

CUSTOMER SUCCESS AND SALES SUPPORT

# Table of contents

<b>Contacts &amp; Digital Assets</b> .....	<b>3</b>
<b>Brand</b> .....	<b>4</b>
<b>Parts and Accessories</b> .....	<b>8</b>

## Bowriders

<b>VR4</b> .....	<b>9</b>
<b>V20 &amp; V20i</b> .....	<b>13</b>
<b>VR 6, I/O and OB</b> .....	<b>19</b>

## Deck boats

<b>M17</b> .....	<b>23</b>
<b>D20, OB</b> .....	<b>27</b>
<b>D20I, I/O</b> .....	<b>30</b>
<b>D22, OB</b> .....	<b>33</b>
<b>D22I, I/O</b> .....	<b>36</b>
<b>E16</b> .....	<b>39</b>
<b>E18</b> .....	<b>40</b>

## Center consoles

<b>T18 Bay</b> .....	<b>41</b>
<b>Trophy 20 CC</b> .....	<b>44</b>
<b>Trophy 22 CC</b> .....	<b>47</b>
<b>Trophy 24 CC</b> .....	<b>50</b>

## Side console

<b>Trophy 22 SC</b> .....	<b>53</b>
---------------------------	-----------

## Overnight

<b>Trophy 23 Explorer</b> .....	<b>56</b>
<b>Trophy 25 Explorer</b> .....	<b>59</b>
<b>Trophy 29 Explorer</b> .....	<b>62</b>
<b>Trophy 23 Pilothouse</b> .....	<b>65</b>
<b>Trophy 25 Pilothouse</b> .....	<b>68</b>

# Who to contact

## Warranty

For warranty inquiries, claims, ownership/registration, labor rate affidavits & inquiries, please email [warranty@bayliner.com](mailto:warranty@bayliner.com)

## Part Orders

For part order inquiries and part number research, please contact [parts@bayliner.com](mailto:parts@bayliner.com)

## Troubleshooting

For pre-authorizations and troubleshooting, please contact [techsupport@bayliner.com](mailto:techsupport@bayliner.com)

# Digital assets

## Marketing resources

Bayliner's Digital Asset Library provides a host of resources you can utilize to engage your customers with compelling branded content and up-to-date product information. Visit the Digital Asset Library for product spec sheets, catalogs, POP materials and other brand assets at [marketing.bayliner.com](http://marketing.bayliner.com).

## Bayliner image gallery

This is Bayliner's easy-to-use online archive of product and lifestyle imagery. The Image Gallery houses three years' worth of product shots, as well as editorial images—all available for download and use for your marketing purposes at [bayliner.smugmug.com](http://bayliner.smugmug.com).

## Bayliner on social media

Bayliner has an ever-growing presence on Facebook, YouTube, TikTok and Instagram, with over 100,00 fans on Facebook alone.

[facebook.com/baylinerboats](https://facebook.com/baylinerboats)  
[youtube.com/user/baylinerboating](https://youtube.com/user/baylinerboating)  
[tiktok.com/@baylinerboats](https://tiktok.com/@baylinerboats)  
[instagram.com/baylinerboats](https://instagram.com/baylinerboats)  
[youtube.com/@bayliner](https://youtube.com/@bayliner)

# What is Bayliner all about?



## Bowriders

Proven  
Stylish  
Value

- ...Leading runabout brand for more than 65 years
- ...Sporty design and well-appointed interior
- ...More boat for your money, with interior space, storage and features

## Deck Boats

Stable  
Social  
Versatile  
Value

- ...Wide beam provides exceptional stability
- ...Spacious layout for passengers, gear and entertaining
- ...Configurations allow you to cruise, cove, fish or enjoy tow sports
- ...More interior space, storage and amenities for your money

## Center Consoles

Versatile  
Easy  
Affordable

- ...The fishable platform can also be used for tow sports or cruising
- ...Easy to operate, launch/retrieve, trailer, and maintain
- ...Priced for mass appeal

# Our brand

## Affordable

Bayliner is the value leader in recreational boating.

BENEFITS:

**Easy to purchase**  
**Feature/price balance**

## Widely Known

Bayliner has been putting families around the world on the water for more than 65 years.

BENEFITS:

**Peace of mind**  
**Enhanced resale value**

## Intuitive

Bayliner designs products that are usable and inviting to boaters of all skill levels.

BENEFITS:

**Ease of use**  
**Multi-use**

## Fit for Purpose

Bayliner serves owners who simply love spending time on the water with family and friends.

BENEFITS:

**Multi-year CSI Award recipient**  
**Industry leading warranty coverage**



# Our dealers

## Professionalism

Nurture a reputation in your community as good people to do business with.

FOCUS:

**Facility is clean, inviting and fully featured**  
**Staff is courteous, knowledgeable and attentive**

## Visible

Foster community connection through all walks of life to grow your business, your people and your customer base.

FOCUS:

**Digitally proficient**  
**Promotionally driven**  
**Event-minded**

## Customer experience

Respect for the customer balanced with an attitude of fairness that nurtures our mutual business relationship.

FOCUS:

**Listen**  
**Follow up and through**



# Our people

## Winning attitude

A mindset that going above and beyond is standard operating procedure.

ATTRIBUTES:

**Positive attitude**  
**Can-do approach**

## Relationship

Communication creates a human connection.

ATTRIBUTES:

**Ability to build rapport**  
**Humble and empathetic**

## Professionalism

Conduct yourself according to the Golden Rule:  
Treat others the way you would like to be treated.

ATTRIBUTES:

**Courteous**  
**Respectful**

## Customer service

Respect for the customer balanced with an attitude of fairness that nurtures our mutual business relationship.

ATTRIBUTES:

**Active listener**  
**Successful follow-up and follow through**



# Parts and accessories

Bayliner offers a wide variety of optional parts and accessories for each boat model. Some are available as an option with the boat at the time of manufacture, others are available at a later date through our Parts Department. Our Parts Department also exclusively offers specialized options for several models. A list of the available options is provided by model in this handbook. Dealers can order Parts & Accessories through COMPASS > Parts > Orders

Questions/comments? Please contact our **Customer Service Department at (865) 971-6232** or through the toll-free parts and service line we have established for your territory.

## Deck boat, optional add-ons



Bimini top



Bow filler cushions



Ski pylon, outboard models only



Portable head



Extended swim platform (sterndrive models only)



Premium upholstery



Bow table



Bow wind block (requires bow filler cushion)

## Bowrider, optional add-ons



Bimini top



Bow filler cushions



Bow well and cockpit cover



Cockpit table



Extended swim platform, sterndrive models only



Coastline upholstery



ProArc Tower

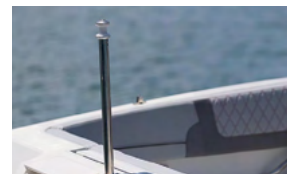

Ski pylon, outboard models only



Windshield with opening center panel



Digital dash w/USB and charging ports



# VR4

<b>LENGTH OVERALL (LOA)</b>	<b>18' 9"</b>	<b>5.7 M</b>
<b>WIDTH (BEAM)</b>	<b>7' 6"</b>	<b>2.8 M</b>
<b>MAX PEOPLE CAPACITY</b>	<b>7</b>	<b>7</b>
<b>MAX HORSEPOWER</b>	<b>150 HP</b>	<b>200 HP</b>
<b>DEADRISE</b>	<b>19°</b>	<b>19°</b>
<b>APPROX WEIGHT W/ STANDARD ENGINE</b>	<b>2,822 LBS</b>	<b>1,280 KG</b>
<b>MAX PEOPLE WEIGHT</b>	<b>1,155 LBS</b>	<b>524 KG</b>
<b>FUEL CAPACITY</b>	<b>33 GAL</b>	<b>125 L</b>
<b>DRAFT MIN</b>	<b>N/A</b>	<b>N/A</b>
<b>DRAFT MAX</b>	<b>2' 10"</b>	<b>0.86 M</b>
<b>BEAM ON TRAILER</b>	<b>8' 6"</b>	<b>2.6 M</b>



Specification dimensions are approximate and subject to variance. Colors, graphics and some equipment shown, subject to change without notice.

## Standard features

### Electrical

- Battery Switch
- Automatic Bilge Pump
- 12V Blower

### Cockpit

- Standard Speakers (4)
- Cup Holders (6)
- Mooring Cleats (4)
- Fuel Fill w/ Integrated Vent
- Glove Box
- Helm Seat w/ 180 Degree Swivel
- In-Floor Ski/Wakeboard Storage
- Waterproof 120-Watt AM/FM Stereo w/Bluetooth Capability

### Trailer

- Single Axle Painted Trailer w/Brakes and Swing Tongue (Black)

### Engine

- 115 HP Mercury® FourStroke EFI Outboard

### Helm

- Multi-Function Gauges w/Fog Resistant Glass Lenses: Fuel, Speedometer, Tachometer, Voltmeter
- 12V Accessory Outlet
- 12V Horn
- Helm Bucket Seat
- Side-Mounted Engine Controls w/Trim & Tilt Switch in Handle
- Tilt Steering
- Custom Sport Steering Wheel
- Mechanical Cable Steering (Outboard Models)
- Analog Trim Indicator
- Sport Windshield w/Opening Center Panel

### Hull & Deck

- Bow & Transom Eyes (3)
- 12V Navigation Lights
- Fiberglass Floor Liner
- Sport Windshield w/Opening Center Panel
- Swim Platform w/Telescoping Ladder
- V-Hull for Added Performance



### Exterior color

- Solid White Hull
- Solid Rally Red hull
- Solid Black hull
- Solid Blue hull
- Solid Gray hull
- VR Sport Package (Red)
- White bottom w/ Rally Red hull
- White bottom w/ Black hull
- White bottom w/ Blue hull
- White bottom w/ Gray hull
- Impulse Blue w/ White hull
- VR Sport Package (Blue)

### Interior color

- Graphite (Gray)
- Coastline (Tan)
- Gray/White

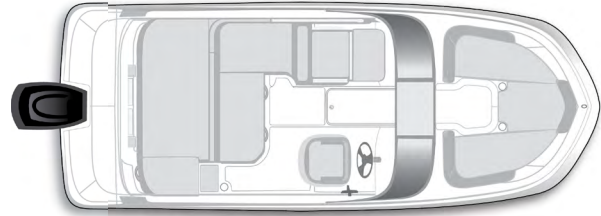

## Optional add-ons

### Engines

- 115 HP Mercury® FourStroke Command Thrust EFI Outboard
- 115 HP Mercury® Pro XS XL Command Thrust Outboard
- 150 HP Mercury® FourStroke EFI Outboard
- Hydraulic Steering System (115 HP and Below)

### Tops

- Bimini, 6' Top w/Boot ★
- ProArc Tower
- Tower Speaker Option

### Canvas

- Snap-On Bow Well & Cockpit Cover ★

### Windshield

- Windshield w/Opening Center & Side Wings
- Sport Windshield w/Opening Center Panel

### Floor Covering

- Cockpit Flooring Mat (Gray) ★
- Cockpit Flooring Mat (Tan) ★
- Woven Floor Covering (Gray)
- Woven Floor Covering (Tan)

### Seats & Upholstery

- Bow Filler Cushion
- Aft Filler Cushion (OB Only)

### Sound System

- Rockford Fosgate® System (4-speaker) ★
- Tower Speakers

### Lighting

- Exterior Lighting (LED Docking Lights, 2x Rear Underwater Lights)
- Interior Lighting

### Water Sports

- Wakeboard Rack (1)
- Wakeboard Rack (2)
- Ski Tow Pylon (OB Only)

### Swim Platforms

- Swim Platform Mat (Gray)
- Swim Platform Mat (Teak)

### Convenience Options

- Bimini Top w/ Boot
- Cockpit Table
- Digital Depth Indicator ★
- High Altitude Prop
- Stainless Steel Package
- Pro Arc Tower w/Integrated Top
- Bow Wind Block (Requires Bow Filler Cushion)
- Dual Battery Trays w/Switch
- 7" Digital Dash w/Engine Data
- Wireless Phone Charger

### Trailer

- Single Axle Painted Trailer w/ Brakes & Swing Tongue

★ Popular option

\* CANADA AND INTERNATIONAL ONLY



## Exterior color

- Solid White Hull
- Solid Rally Red hull
- Solid Black hull
- Solid Blue hull
- Solid Gray hull
- VR Sport Package (Red)
- White bottom w/ Rally Red hull
- White bottom w/ Black hull
- White bottom w/ Blue hull
- White bottom w/ Gray hull
- Impulse Blue w/ White hull
- VR Sport Package (Blue)

## Interior color

- Graphite (Gray)
- Coastline (Tan)
- Gray/White

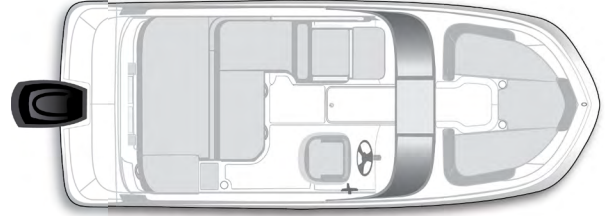

## Tech Package

*Includes Standard Features plus:*

- Interior and Exterior Lighting
- Wireless Phone Charger

## Comfort Package

*Includes Standard Features plus:*

- Cockpit Table
- Bow Block Off w/Bow Filler Cushion

## Bimini Package

*Includes Standard Features plus:*

- Bimini Top w/Boot
- Stainless Steel Upgrade
- Canvas Bow Well
- Cockpit Cover

## Tower Package

*Includes Standard Features plus:*

- ProArc Tower w/ Integrated Top
- Stainless Steel Upgrade
- Bow Well
- Cockpit Cover Options

★ Popular option

\* CANADA AND INTERNATIONAL ONLY





## Engine performance data

### Outboard

#### 115 HP Mercury® FourStroke EFI Outboard

Cruise mph	28.6
WOT mph	43
Propeller	19 P Black Max
Range	N/A
Weight as tested	3,250 lbs

*This information is provided for comparison purposes and is intended to show relative performance between different boats and engine options. A specific boat's performance will be affected by water and weather conditions, altitude, condition of boat, actual load, engine and propeller. Engine performance data is based on boat in cruise load weight condition. Cruise load weight condition consists of boat with typical options, full tanks, all safety gear, two passengers and typical storage. Cruising range based on cruise speed at cruise load with 10% fuel reserve at rated range.*

## Features

1. Simple and intuitive helm controls
2. Lightweight model for easy storage, trailering and handling
3. Spacious cockpit for socializing
4. V-Hull allows for a smooth ride with higher speed and improved performance
5. High attention to detail, fit and finish with premium stitched upholstery
6. Molded-in storage and cup holders
7. Award-winning Mercury® engine performance and reliability
8. Filler cushion turns bow into a sun lounger
9. Large sunpad





# V20

LENGTH OVERALL (LOA)	20' 4"	6.29 M
HULL LENGTH	20' 3"	6.17 M
WIDTH (BEAM)	8' 4"	2.54 M
MAX PEOPLE CAPACITY	10	10
MAX HORSEPOWER OFFERED	175 HP	175 HP
DEADRISE	20°	20°
FUEL CAPACITY	45 GAL	170 L
DRAFT MIN	1' 7"	0.6 M
DRAFT MAX	2' 10"	0.86 M
DRY BOAT WEIGHT W/ STANDARD ENGINE	3,380 LBS	1,409 KG



Specification dimensions are approximate and subject to variance.  
Colors, graphics and some equipment shown, subject to change without notice.

## Standard features

### Electrical

- Battery Switch
- 500 GPH Bilge Pump (Automatic)

### Cockpit

- Standard Speakers (4)
- Cup Holders (6)
- Grab Handles (6)
- Mooring Cleats (4)
- Fuel Fill w/ Integrated Vent
- Glove Box
- Cockpit Table
- Helm Seat w/ 180° Swivel
- In-Floor Ski/Wakeboard Storage
- 120-Watt AM/FM Stereo w/ MP3 Capability
- Integrated Cooler

### Interior Color

- Graphite (Gray) Upholstery
- Coastline Tan Upholstery

### Helm

- Multi-Function Gauges w/ Fog-Resistant Glass Lenses: Fuel, Speedometer, Tachometer, Voltmeter
- 12V Accessory Outlet
- 12V Horn
- Analog Trim Indicator
- Side-Mounted Engine Controls w/ Trim & Tilt Switch in Handle
- Tilt Steering
- Custom Sport Steering Wheel

### Hull & Deck

- 12V Navigation Lights
- Courtesy Light (3)
- Fiberglass Floor Liner
- Sport Windshield w/ Opening Center Panel
- Swim Platform w/ Telescoping Ladder
- V-hull for Added Performance
- Self Bailing Cockpit



### Exterior color

- Solid White Hull
- Solid Black hull
- Solid Blue hull
- Solid Gray hull
- Solid Impulse Blue hull
- White bottom w/ Black hull
- White bottom w/ Blue hull
- White bottom w/ Gray hull
- White bottom w/ Impulse Blue hull

### Interior color

- Graphite (Gray)
- Coastline (Tan)



## Optional add-ons

### Engines

- 150 HP EFI 4 Stroke-Mercury Outboard
- Mercury 175XL Pro XS 4 Stroke

### Interior Color

- Coastline Tan Interior
- Graphite (Gray) Interior

### Options

- Digital Dash w/ Mercury Vessel View 7"
- Digital Dash w/ Mercury Vessel View 9"
- Stereo - Rockford Fosgate
- Stereo - Rockford Fosgate Stage 2
- Ski Tow Pylon
- Digital Depth Indicator
- High Altitude Prop
- Battery Switch-Dual w/ 2nd Tray Single Engine
- Flooring Gray Or Tan

## Bimini Package

*Includes Standard Features plus:*

- Bimini Top with Boot
- Stainless Steel Upgrade
- Bow Well and Cockpit Cover

## Comfort Package

*Includes Standard Features plus:*

- Bow Filler Cushion
- Bow Block Off (Req. Bow Filler Cushion)
- Cockpit Table

## Tech Package

*Includes Standard Features plus:*

- Blue-Thru Hull Underwater Lights
- Wireless Phone Charger

## Tower Package

*Includes Standard Features plus:*

- Proarc Tower w/ Integrated Top
- Stainless Steel Upgrade
- Bow Well And Cockpit Cover

★ Popular option

\* CANADA AND INTERNATIONAL ONLY





## Engine performance data

### 150HP Mercury FS XL

Cruise mph	23.0
WOT mph	41.1
Propeller	15 P Black Max
Range	100 nm
Weight as tested	4,062 lbs

### 115 Pro XS HP

Cruise mph	20.3
WOT mph	34.1
Propeller	15 P Spitfire
Range	129 nm
Weight as tested	3,989 lbs

### 175 Pro XS HP

Cruise mph	25.7
WOT mph	44.6
Propeller	16 P Enertia
Range	99 nm
Weight as tested	4,088 lbs

*This information is provided for comparison purposes and is intended to show relative performance between different boats and engine options. A specific boat's performance will be affected by water and weather conditions, altitude, condition of boat, actual load, engine and propeller. Engine performance data is based on boat in cruise load weight condition. Cruise load weight condition consists of boat with typical options, full tanks, all safety gear, two passengers and typical storage. Cruising range based on cruise speed at cruise load with 10% fuel reserve at rated range.*

## Features

1. Simple, intuitive controls at the helm
2. Lightweight model for easy storage, trailering and handling
3. Large cockpit with adjustable seating for entertaining or lounging
4. V-Hull allows for a smooth ride with higher speed and less splashing
5. Premium stitched upholstery
6. Molded-in storage and cup holders
7. Award-winning Mercury® engine performance and reliability
8. Filler cushion turns bow into a sun lounger
9. Large sunpad
10. Integrated ski locker





# V201

LENGTH OVERALL (LOA)	20' 4"	6.29 M
HULL LENGTH	20' 3"	6.17 M
WIDTH (BEAM)	8' 4"	2.54 M
MAX PEOPLE CAPACITY	9	9
MAX HORSEPOWER	250 HP	250 HP
DEADRISE	20°	20°
FUEL CAPACITY	45 GAL	170 L
DRAFT MIN	1' 8"	0.51 M
DRAFT MAX	2' 11"	0.89 M
DRY BOAT WEIGHT W/ STANDARD ENGINE	3,985 LBS	1,592 KG



Specification dimensions are approximate and subject to variance.  
Colors, graphics and some equipment shown, subject to change without notice.

## Standard features

### Electrical

- Battery Switch
- 500 GPH Bilge Pump (Automatic)

### Cockpit

- Standard Speakers (4)
- Cup Holders (6)
- Grab Handles (6)
- Mooring Cleats (4)
- Fuel Fill w/ Integrated Vent
- Glove Box
- Cockpit Table
- Helm Seat w/ 180° Swivel
- In-Floor Ski/Wakeboard Storage
- 120-Watt AM/FM Stereo w/ MP3 Capability
- Integrated Cooler
- Stainless Steel Tow Ring

### Interior Color

- Graphite (Gray) Upholstery
- Coastline Tan Upholstery

### Helm

- Multi-Function Gauges w/ Fog-Resistant Glass Lenses: Fuel, Speedometer, Tachometer, Voltmeter
- 12V Accessory Outlet
- 12V Horn
- Analog Trim Indicator
- Side-Mounted Engine Controls w/ Trim & Tilt Switch in Handle
- Tilt Steering
- Custom Sport Steering Wheel

### Hull & Deck

- 12V Navigation Lights
- Courtesy Light (3)
- Fiberglass Floor Liner
- Sport Windshield w/ Opening Center Panel
- Swim Platform w/ Telescoping Ladder
- V-hull for Added Performance
- Self Bailing Cockpit



# V20I



## Exterior color

- Solid White Hull
- Solid Black hull
- Solid Blue hull
- Solid Gray hull
- Solid Impulse Blue hull
- White bottom w/ Black hull
- White bottom w/ Blue hull
- White bottom w/ Gray hull
- White bottom w/ Impulse Blue hull

## Interior color

- Graphite (Gray)
- Coastline (Tan)

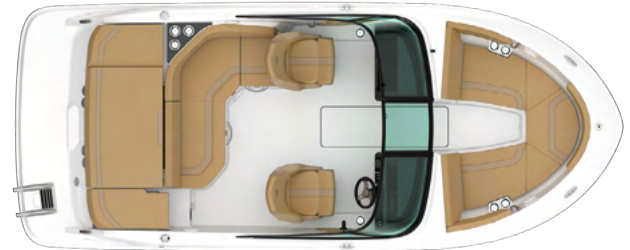

## Optional add-ons

### Engines

- Mercruiser 250 HP

### Interior Color

- Coastline Tan Interior
- Graphite (Gray) Interior

### Options

- Digital Dash w/ Mercury Vessel View 7"
- Digital Dash w/ Mercury Vessel View 9"
- Stereo - Rockford Fosgate
- Stereo - Rockford Fosgate Stage 2
- Digital Depth Indicator
- High Altitude Prop
- Battery Switch-Dual w/ 2nd Tray Single Engine
- Flooring Gray Or Tan

## Bimini Package

*Includes Standard Features plus:*

- Bimini Top with Boot
- Stainless Steel Upgrade
- Bow Well and Cockpit Cover

## Comfort Package

*Includes Standard Features plus:*

- Bow Filler Cushion
- Bow Block Off (Req. Bow Filler Cushion)
- Cockpit Table

## Tech Package

*Includes Standard Features plus:*

- Blue-Thru Hull Underwater Lights
- Wireless Phone Charger

## Tower Package

*Includes Standard Features plus:*

- Proarc Tower w/ Integrated Top
- Stainless Steel Upgrade
- Bow Well And Cockpit Cover

★ Popular option

\* CANADA AND INTERNATIONAL ONLY



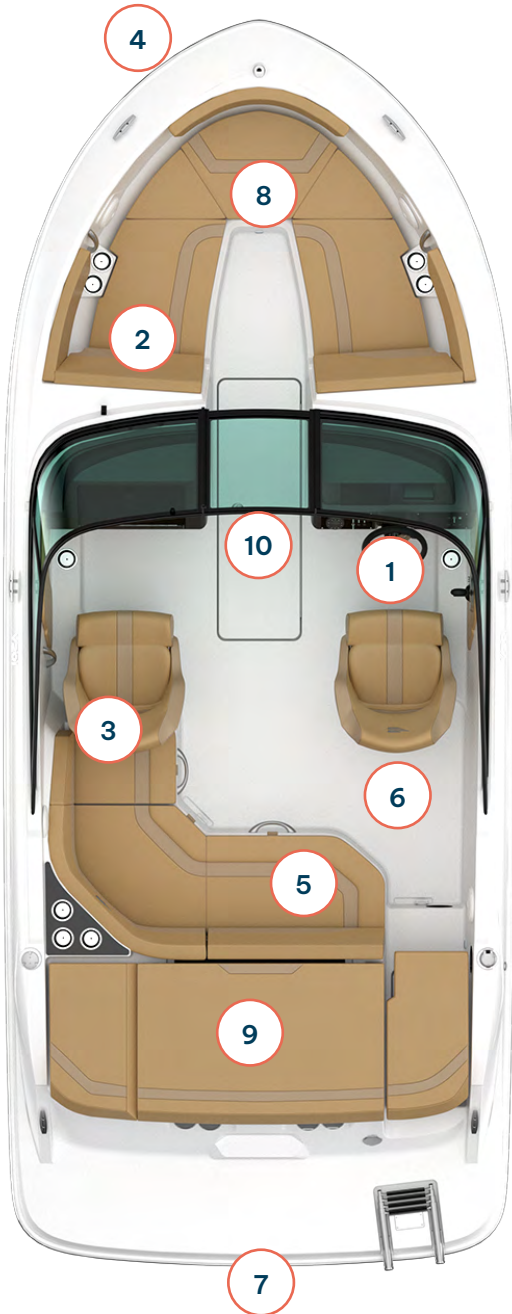

## Engine performance data

### 200 HP Mercruiser 4.5L V6 Alpha

Cruise mph . . . . .	24.4
WOT mph . . . . .	43.5
Propeller . . . . .	19 P Black Max
Range . . . . .	108 nm
Weight as tested . . . . .	4,692 lbs

### 250 HP Mercruiser 4.5L V6 Alpha

Cruise mph . . . . .	22.9
WOT mph . . . . .	45.3
Propeller . . . . .	19 P Black Max
Range . . . . .	N/A
Weight as tested . . . . .	4,680 lbs

*This information is provided for comparison purposes and is intended to show relative performance between different boats and engine options. A specific boat's performance will be affected by water and weather conditions, altitude, condition of boat, actual load, engine and propeller. Engine performance data is based on boat in cruise load weight condition. Cruise load weight condition consists of boat with typical options, full tanks, all safety gear, two passengers and typical storage. Cruising range based on cruise speed at cruise load with 10% fuel reserve at rated range.*

## Features

1. Simple, intuitive controls at the helm
2. Lightweight model for easy storage, trailering and handling
3. Large cockpit with adjustable seating for entertaining or lounging
4. V-Hull allows for a smooth ride with higher speed and less splashing
5. Premium stitched upholstery
6. Molded-in storage and cup holders
7. Award-winning Mercury® engine performance and reliability
8. Filler cushion turns bow into a sun lounger
9. Large sunpad
10. Integrated ski locker





LENGTH OVERALL (LOA), I/O & OB	22' 7"	6.9 M
WIDTH (BEAM)	8' 0"	2.44 M
MAX PEOPLE CAPACITY, I/O	10	10
MAX PEOPLE CAPACITY, OB	10	10
MAX HORSEPOWER, I/O	250 HP	250 HP
MAX HORSEPOWER, OB	200 HP	200 HP
DEADRISE	20°	20°
APPROX WEIGHT W/ STANDARD ENGINE	3,797 LBS	1,722 KG
MAX PEOPLE WEIGHT, I/O	1,700 LBS	771 KG
MAX PEOPLE WEIGHT, OB	1,654 LBS	750 KG
FUEL CAPACITY	33 GAL	125 L
BEAM ON TRAILER	8' 6"	2.6 M
DRAFT MIN	N/A	N/A
DRAFT MAX	2' 10"	0.86 M

# VR6



Specification dimensions are approximate and subject to variance.  
Colors, graphics and some equipment shown, subject to change without notice.

## Standard features

### Electrical

- Battery Switch
- Automatic Bilge Pump
- 12V Blower

### Cockpit

- Speakers (4), Cup Holders (6)
- Grab Handles, Mooring Cleats (6)
- Fuel Fill w/ Integrated Vent
- Glove Box
- Helm Seat w/ 180 Degree Swivel
- In-Floor Ski/Wakeboard Storage
- Portside Companion Seat (3-Position)
- Large Lockable Port-Side Changing Room and Storage Compartment
- Self-Bailing Cockpit
- Integrated Cooler
- Waterproof 120-Watt AM/FM Stereo w/ Bluetooth Capability

### Engine

- 150 HP Mercury® FourStroke EFI Outboard, OB

### Helm

- Multi-Function Gauges w/ Fog Resistant Glass Lenses
- 12V Accessory Outlet
- 12V Horn
- Helm Bucket Seat
- Side-Mounted Engine Controls w/ Trim & Tilt Switch in Handle
- Tilt Steering
- Custom Sport Steering Wheel
- Analog Trim Indicator

### Hull & Deck

- Bow & Transom Eyes (3)
- 12V Navigation Lights
- Stainless Steel Tow Ring (I/O only)
- Fiberglass Floor Liner
- Sport Windshield w/ Opening Center Panel
- Swim Platform w/ Telescoping Ladder
- V-Hull for Added Performance

### Trailer

- Tandem Axle Painted Trailer w/ Brakes & Swing Tongue (Black)



## Exterior color

- Solid White Hull
- Solid Rally Red hull
- Solid Black hull
- Solid Blue hull
- Solid Gray hull
- VR Sport Package (Red)
- White bottom w/ Rally Red hull
- White bottom w/ Black hull
- White bottom w/ Blue hull
- White bottom w/ Gray hull
- Impulse Blue w/ White hull
- VR Sport Package (Blue)

## Interior color

- Graphite (Gray)
- Coastline (Tan)
- Gray/White

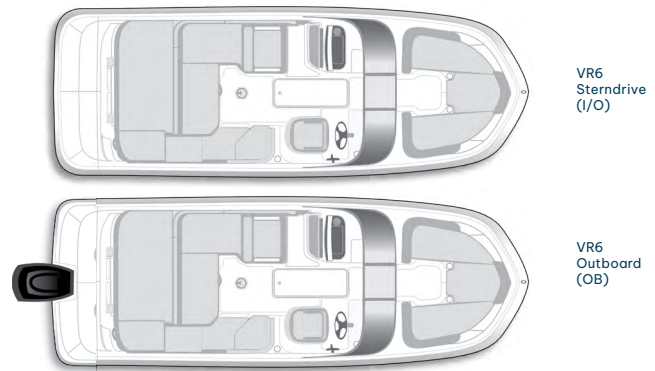

## Optional add-ons

### I/O Engines

- 200 HP MerCruiser® ECT 4.5L MPI Sterndrive (Alpha 1 Outdrive)
- 200 HP MerCruiser® 4.5L MPI Sterndrive (Alpha 1 Outdrive)\*
- 250 HP MerCruiser® ECT 4.5L MPI Sterndrive (Alpha 1 Outdrive)
- 250 HP MerCruiser® 4.5L MPI Sterndrive (Alpha 1 Outdrive)\*

### OB Engines

- 200 HP Mercury® FourStroke Outboard (Black)
- High Altitude Prop

### Steering

- Power Steering - 200HP L4 Option, OB

### Tops

- Bimini, 6' Top w/ Boot ★
- ProArc Tower w/ Integrated Top
- Tower Speaker Option

### Canvas

- Snap-On Bow Well & Cockpit Cover ★

### Windshield

- Windshield w/ Opening Center & Side Wings
- Sport Windshield w/ Opening Center Panel

### Floor Covering

- Cockpit Flooring (Gray Mat) ★
- Cockpit Flooring (Tan Mat) ★
- Snap-In Seagrass Woven Floor Covering (Tan)
- Snap-In Seagrass Woven Floor Covering (Gray)

### Seats & Upholstery

- Bow Filler Cushion

### Appearance Package

- Stainless Package
- VR Sport Package (Blue)
- VR Sport Package (Red)

### Sound System

- Rockford Fosgate® System (4-speaker) ★

### Lighting

- Exterior Lighting
- Interior Lighting

### Water Sports

- Wakeboard Rack (1x)
- Wakeboard Rack (2x)
- Ski Tow Pylon (OB only)

### Swim Platforms

- Swim Platform Mat (Gray)
- Swim Platform Mat (Teak)

### Convenience Options

- 7" Glass Dash Screen w/Engine Data
- 9" Glass Dash Screen w/Engine Data
- Bimini Top w/Boot
- Stainless Steel Upgrade
- ProArc Tower w/Integrated Top
- Privacy Curtain
- Cockpit Table
- Digital Depth Indicator ★
- Portable Head
- Bow Wind Block (Requires Bow Filler Cushion)
- Dual Battery Trays w/Switch
- Wireless Phone Charger

★ Popular option

\* CANADA AND INTERNATIONAL ONLY



### Exterior color

- Solid White Hull
- Solid Rally Red hull
- Solid Black hull
- Solid Blue hull
- Solid Gray hull
- VR Sport Package (Red)
- White bottom w/ Rally Red hull
- White bottom w/ Black hull
- White bottom w/ Blue hull
- White bottom w/ Gray hull
- Impulse Blue w/ White hull
- VR Sport Package (Blue)

### Interior color

- Graphite (Gray)
- Coastline (Tan)
- Gray/White

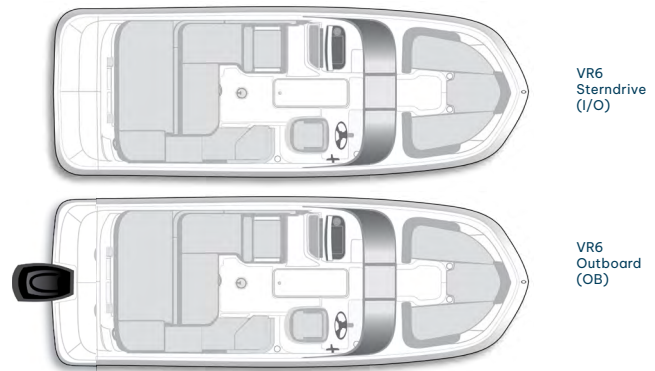

## Optional add-ons

### Trailer

- Tandem Axle Galvanized Trailer w/ Brakes & Swing Tongue
- Tandem Axle Painted Trailer w/ Brakes & Swing Tongue (Black)

## Tech Package

*Includes Standard Features plus:*

- Interior and Exterior Lighting
- Wireless Phone Charger

## Comfort Package

*Includes Standard Features plus:*

- Cockpit Table
- Bow Block Off w/Bow Filler Cushion

## Bimini Package

*Includes Standard Features plus:*

- Bimini Top w/Boot
- Stainless Steel Upgrade
- Canvas Bow Well
- Cockpit Cover

## Tower Package

*Includes Standard Features plus:*

- ProArc Tower w/ Integrated Top
- Stainless Steel Upgrade
- Bow Well
- Cockpit Cover Options





## Engine performance data

### Outboard

#### 150 HP Mercury® FourStroke EFI Outboard

Data Not Yet Available

#### 200 HP 4 Stroke L6 Verado

Data Not Yet Available

### Sterndrive

#### 200 HP MerCruiser® ECT 4.5L MPI Sterndrive (Alpha 1 Outdrive)

Cruise mph	32.8
WOT mph	45.8
Propeller	19 P Black Max
Range	104.3 nm
Weight as tested	4,430 lbs

#### 250 HP Mercury 4.5L A1 Sterndrive

Cruise mph	32.3
WOT mph	49.9
Propeller	17 P Enertia
Range	102.9 nm
Weight as tested	4,430 lbs

#### 250 HP Mercury 4.5L B3 Sterndrive Data Not Yet Available

*This information is provided for comparison purposes and is intended to show relative performance between different boats and engine options. A specific boat's performance will be affected by water and weather conditions, altitude, condition of boat, actual load, engine and propeller. Engine performance data is based on boat in cruise load weight condition. Cruise load weight condition consists of boat with typical options, full tanks, all safety gear, two passengers and typical storage. Cruising range based on cruise speed at cruise load with 10% fuel reserve at rated range.*

## Features

1. Simple, intuitive controls at the helm
2. Lightweight model for easy storage, trailering and handling
3. Large cockpit with adjustable seating for lounging or entertaining
4. V-Hull allows for a smooth ride with higher speed and improved performance
5. Premium stitched upholstery
6. Molded-in storage and cup holders
7. Award-winning Mercury® engine performance and reliability
8. Filler cushion turns bow into a sun lounge
9. Large sunpad w/integrated headrest
10. Integrated ski locker





# M17



LENGTH OVERALL (LOA)	17' 0"	5.18 M
WIDTH (BEAM)	7' 6"	2.30 M
MAX PEOPLE CAPACITY	7	7
MAX HORSEPOWER	90 HP	90 HP
DEADRISE	16°	16°
APPROX WEIGHT W/ STANDARD ENGINE	1,984 LBS	900 KG
APPROX WEIGHT W/ TRAILER	2,457 LBS	1,115 KG
MAX PEOPLE WEIGHT	1,000 LBS	454 KG
FUEL CAPACITY	18 GAL	72 L
DRAFT MIN	9.6"	0.24 M
DRAFT MAX	2' 3"	0.61 M
HEIGHT ON TRAILER <sup>1</sup>	6' 8"	1.83 M
BEAM ON TRAILER	8' 3"	2.51 M
STORAGE LENGTH <sup>2</sup>	20' 1"	6.10 M
BRIDGE CLEARANCE W/ OPTIONS	3' 5"	1.06 M

Specification dimensions are approximate and subject to variance.

<sup>1</sup> Tongue jack lowered all the way down.

<sup>2</sup> Stern drive in down position and trailer tongue swung to side.

Colors, graphics and some equipment shown, subject to change without notice.

## Standard features

### Electrical

Battery Switch  
Bilge Pump (Automatic)

### Cockpit

Cup Holders (9)  
Grab Handles (4)  
Mooring Cleats (4)

### Fuel

18 Gal Internal Tank w/ Integrated Vent

### Engine

90 HP Mercury® FourStroke EFI Outboard Non-DTS

### Helm

Multi-Purpose Gauge: Speedometer, Voltmeter, Fuel  
12V Accessory Outlet  
12V Horn  
Side-Mounted Engine Controls w/ Trim & Tilt Switch In Handle  
Custom Sport Steering Wheel  
Waterproof 120-Watt AM/FM Stereo W/ Bluetooth

### Hull & Deck

Bow & Transom Eyes (3)  
12V Navigation Lights  
M-Hull Design for Added Stability  
Fiberglass Floor Liner  
Single Helm Windscreen  
Swim Platform w/ Telescoping Ladder  
Bimini, 6' Top w/ Boot  
Mooring Cover

### Trailer

Single Axle Painted Trailer w/ Swing Tongue (Black)



### Exterior color

- Solid White Hull
- Solid Rally Red hull
- Solid Impulse Blue hull
- Solid Black hull

### Interior color

- Gray w Black accent



## Optional add-ons

### Convenience Options

- Dual Acrylic Windscreen
- High Altitude Prop
- Hydraulic Steering
- Full Windshield w/ Opening CTR Panel

### Floor Covering

- Cockpit Flooring Mat (Gray) ★

### Water Sports

- Ski Tow Arch ★
- Ski Tow Pylon ★

### Trailer

- Single Axle Galvanized Trailer

## M Comfort Package

*Includes Standard Features plus:*

- Bow Filler Cushion
- Bow Block-Off
- Portside Lounge Seat





## Engine performance data

### Outboard

#### Mercury 60 Four Stroke

Cruise mph	21.2
WOT mph	29.5
Propeller	Spitfire 10.3 x 13 x 4 BL
Range	111 nm
Weight as tested	2,488 lbs

#### Mercury 75 Four Stroke

Cruise mph	18.7
WOT mph	32.3
Propeller	Spitfire 13.8 x 13 x 4 BL
Range	101 nm
Weight as tested	2,600 lbs

#### Mercury 80 Four Stroke

Cruise kn	16.2
WOT kn	28.1
Propeller	Spitfire 13.8 x 13 x 4 BL
Range	163 km
Weight as tested	1,180 kg

#### Mercury 90 Four Stroke

Cruise mph	18.6
WOT mph	34.1
Propeller	Spitfire 13.8 x 13 x 4 BL
Range	97 nm
Weight as tested	2,600 lbs

*This information is provided for comparison purposes and is intended to show relative performance between different boats and engine options. A specific boat's performance will be affected by water and weather conditions, altitude, condition of boat, actual load, engine and propeller. Engine performance data is based on boat in cruise load weight condition. Cruise load weight condition consists of boat with typical options, full tanks, all safety gear, two passengers and typical storage. Cruising range based on cruise speed at cruise load with 10% fuel reserve at rated range.*





## Engine performance data

### Outboard

#### Mercury 100 Four Stroke

Cruise kn	.16.1
WOT kn	29.6
Propeller	Spitfire 13.8 x 13 x 4 BL
Range	156 km
Weight as tested	1,180 kg

#### Mercury 115 Four Stroke

Cruise kn	18.9
WOT kn	34.3
Propeller	Spitfire 12.8 x 15 x 4 BL
Range	172 km
Weight as tested	1,180 kg

*This information is provided for comparison purposes and is intended to show relative performance between different boats and engine options. A specific boat's performance will be affected by water and weather conditions, altitude, condition of boat, actual load, engine and propeller. Engine performance data is based on boat in cruise load weight condition. Cruise load weight condition consists of boat with typical options, full tanks, all safety gear, two passengers and typical storage. Cruising range based on cruise speed at cruise load with 10% fuel reserve at rated range.*

## Features

1. Simple and intuitive helm controls
2. Lightweight model for easy storage, trailering and handling
3. Nook-style cockpit configuration, optimized for socializing seating
4. Beam forward design allowing more room for passenger comfort and storage
5. Premium stitched upholstery
6. Molded-in storage and cup holders
7. Award-winning Mercury® engine performance and reliability
8. Filler cushion turns bow into a sun lounger
9. M-Hull foundation that allows ease on and off trailer due to M-Hull design and trailer bunks configuration
10. Integrated cooler





# D20

LENGTH OVERALL (LOA)	19' 6"	5.9 M
WIDTH (BEAM)	8' 1"	2.46 M
MAX PEOPLE CAPACITY	10	10
MAX HORSEPOWER	150 HP	150 HP
DEADRISE	18°	18°
DRY BOAT WEIGHT	3,396 LBS	1,540 KG
MAX PEOPLE WEIGHT	1,643 LBS	745 KG
FUEL CAPACITY	33 GAL	124.9 L
DRAFT MIN	1' 7"	0.48 M
DRAFT MAX	2' 7"	0.79 M
BEAM ON TRAILER	8' 6"	2.46 M



Specification dimensions are approximate and subject to variance.  
Colors, graphics and some equipment shown, subject to change without notice.

## Standard features

### Electrical

Battery Switch  
Automatic Bilge Pump

### Cockpit

Standard Speakers (4)  
Mooring Cleats (6)  
Cup Holders  
Grab Handles  
Fuel Fill w/ Integrated Vent  
Helm Seat w/ 180° Swivel  
In-Floor Ski/Wakeboard Storage  
Waterproof 120-Watt AM/FM Stereo  
w/ Bluetooth Capability

### Engine

115 HP XL EFI 4 Stroke, Mercury OB

### Helm

Multi-Function Gauges w/ Fog Resistant Glass Lenses:  
Fuel, Speedometer, Tachometer, Voltmeter  
12V Accessory Outlet  
12V Horn  
Side-Mounted Engine Controls w/ Trim & Tilt Switch in Handle  
Tilt Steering  
Mechanical Cable Steering (Outboard Models)  
Analog Trim Indicator  
Custom Sport Steering Wheel

### Hull & Deck

Bow & Transom Eyes (3)  
12V Navigation Lights  
Bow Ladder w/ Hinged Lid  
Anchor Locker  
Fiberglass Floor Liner  
Swim Platform w/ Telescoping Ladder



### Exterior color

- Solid Black hull
- Solid Blue hull
- Solid Gray hull
- Black w/ White bottom
- Blue w/ White bottom
- Gray w/ White bottom

### Interior color

- Gray/White
- Coastline (Tan)



## Optional add-ons

### OB Engines

- 150 HP EFI 4 Stroke - Mercury Outboard
- High Altitude Prop
- Hydraulic Steering System

### Floor Covering

- Flooring (Teak Mat)
- Flooring (Gray Mat)

### Seats & Upholstery

- D Series Gray/White Interior
- D Series Coastline Interior (Tan)

### Trailer

- Painted Swing Tongue S/ A Trailer W/ Brakes
- Galv Swing Tongue S/ A Trailer With Brakes

### Lighting

- Exterior Lighting Package

### Convenience Options

- Simrad 7" Digital Dash w/Engine data
- Digital Depth Indicator
- Fresh Water Shower
- Bow Wind Block (Req. Bow Filler Cushion)
- Bow Table

## Fishing Package

*Includes Standard Features plus:*

- Bow Casting Platform & Seat
- Dual Battery 24V Plug
- Fish Finder

## Max Layout Package

*Includes Standard Features plus:*

- L-Shaped Cockpit Layout
- Snap On Cover
- Wireless Phone Charger

## Dual Console Package

*Includes Standard Features plus:*

- Dual Console Layout w/ Windshield
- Snap On Cover
- Wireless Phone Charger

## Bimini Package

*Includes Standard Features plus:*

- Stainless Steel Upgrade
- Bimini Top w/ Boot
- Battery Switch Dual w/ 2<sup>nd</sup> Tray Single Engine
- Ski Tow Pylon Options

## Tower Package

*Includes Standard Features plus:*

- Stainless Steel Upgrade
- Proarc Tower/Integrated Top
- Battery Switch Dual w/ 2<sup>nd</sup> Tray Single Engine

## Comfort Package

*Includes Standard Features plus:*

- Bow Filler Cushion
- Cockpit Table
- Stereo Rockford Fosgate





## Engine performance data

### Outboard

#### 115 HP Mercury FS CT XL Outboard

Cruise mph	22
WOT mph	31
Propeller	.Black Max 15x17P
Range	.96 nm
Weight as tested	.4,062 lbs

#### 150 HP Mercury FS XL Outboard

Cruise mph	32.3
WOT mph	41
Propeller	.Black Max 15x17P
Range	.118 nm
Weight as tested	.4,210 lbs

*This information is provided for comparison purposes and is intended to show relative performance between different boats and engine options. A specific boat's performance will be affected by water and weather conditions, altitude, condition of boat, actual load, engine and propeller. Engine performance data is based on boat in cruise load weight condition. Cruise load weight condition consists of boat with typical options, full tanks, all safety gear, two passengers and typical storage. Cruising range based on cruise speed at cruise load with 10% fuel reserve at rated range.*

## Features

1. Award winning Mercury engine
2. Premium stitched upholstery
3. Deep gunnels for a safe, dry ride
4. Transitional seating creates ample sun lounging area
5. Ample storage space





# D201

LENGTH OVERALL (LOA)	19' 6"	6 M
WIDTH (BEAM)	8' 1"	2.46 M
MAX PEOPLE CAPACITY	9	9
MAX HORSEPOWER	250 HP	250 HP
DEADRISE	18°	18°
MAX PEOPLE WEIGHT	1,270 LBS	575 KG
FUEL CAPACITY	33 GAL	124.9 L
DRAFT MIN	1' 9"	0.53 M
DRAFT MAX	2' 11"	0.64 M
BEAM ON TRAILER	8' 6"	2.46 M
DRY BOAT WEIGHT W/ STANDARD ENGINE	3,880 LBS	1,759 KG



Specification dimensions are approximate and subject to variance.  
Colors, graphics and some equipment shown, subject to change without notice.

## Standard features

### Electrical

Battery Switch  
Automatic Bilge Pump

### Cockpit

Standard Speakers (4)  
Mooring Cleats (6)  
Cup Holders  
Grab Handles  
Fuel Fill w/ Integrated Vent  
Helm Seat w/ 180° Swivel  
In-Floor Ski/Wakeboard Storage  
Waterproof 120-Watt AM/FM Stereo  
w/ Bluetooth Capability

### Engine

200 HP MerCruiser® ECT 4.5L MPI Sterndrive  
(Alpha 1 Outdrive)

### Helm

Multi-Function Gauges w/ Fog Resistant Glass Lenses:  
Fuel, Speedometer, Tachometer, Voltmeter  
12V Accessory Outlet  
12V Horn  
Side-Mounted Engine Controls w/ Trim & Tilt Switch in Handle  
Tilt Steering  
Mechanical Cable Steering (Outboard Models)  
Analog Trim Indicator  
Custom Sport Steering Wheel

### Hull & Deck

Bow & Transom Eyes (3)  
12V Navigation Lights  
Bow Ladder w/ Hinged Lid  
Anchor Locker  
Fiberglass Floor Liner  
Swim Platform w/ Telescoping Ladder



# D20I



## Exterior color

- Solid Black hull
- Solid Blue hull
- Solid Gray hull
- Black w/ White bottom
- Blue w/ White bottom
- Gray w/ White bottom

## Interior color

- Gray/White
- Coastline (Tan)



## Optional add-ons

### I/O Engines

- High Altitude Prop
- 250 M Mpi/A1 (4.5L) Ect Carb Compliant

### Floor Covering

- Flooring (Teak Mat)
- Flooring (Gray Mat)

### Seats & Upholstery

- DX Series Gray/White Interior
- DX Series Coastline Interior (Tan)

### Trailer

- Painted Swing Tongue S/A Trailer W/ Brakes
- Galv Swing Tongue S/A Trailer With Brakes

### Convenience Options

- Transom Shower
- Bow Table
- Digital Depth Indicator
- Simrad 7" Digital Dash w/VesselView Link
- Bow Block Off (Req. Bow Filler Cushion)
- Exterior Lighting Package
- Swim Platform Extension

## Max Layout Package

*Includes Standard Features plus:*

- L-Shaped Cockpit Layout
- Snap On Cover
- Wireless Phone Charger

## Dual Console Package

*Includes Standard Features plus:*

- Dual Console Layout w/ Windshield
- Snap On Cover
- Wireless Phone Charger

## Bimini Package

*Includes Standard Features plus:*

- Stainless Steel Upgrade
- Bimini Top w/ Boot
- Battery Switch Dual w/ 2<sup>nd</sup> Tray Single Engine

## Tower Package

*Includes Standard Features plus:*

- Stainless Steel Upgrade
- Proarc Tower/Integrated Top
- Battery Switch Dual w/ 2<sup>nd</sup> Tray Single Engine

## Comfort Package

*Includes Standard Features plus:*

- Bow Filler Cushion
- Cockpit Table
- Stereo Rockford Fosgate





## Engine performance data

### Sterndrive

#### 200 HP Mercury 4.5L V6 Alpha Sterndrive

Cruise mph	30.15
WOT mph	40.2
Propeller	Spitfire 14x17P
Range	95 nm
Weight as tested	4,616 lbs

#### 250 HP Mercury 4.5L V6 Alpha Sterndrive

Cruise mph	42.7
WOT mph	49.7
Propeller	Spitfire 14x17P
Range	70 nm
Weight as tested	4,616 lbs

*This information is provided for comparison purposes and is intended to show relative performance between different boats and engine options. A specific boat's performance will be affected by water and weather conditions, altitude, condition of boat, actual load, engine and propeller. Engine performance data is based on boat in cruise load weight condition. Cruise load weight condition consists of boat with typical options, full tanks, all safety gear, two passengers and typical storage. Cruising range based on cruise speed at cruise load with 10% fuel reserve at rated range.*

## Features

1. Award winning Mercury engine
2. Premium stitched upholstery
3. Deep gunnels for a safe, dry ride
4. Transitional seating creates ample sun lounging area
5. Ample storage space





# D22

LENGTH OVERALL (LOA)	21' 6"	6.5 M
WIDTH (BEAM)	8' 6"	2.6 M
MAX PEOPLE CAPACITY	12	12
MAX HORSEPOWER	225 HP	225 HP
DEADRISE	18°	18°
MAX PEOPLE WEIGHT	1,692 LBS	767.4 KG
FUEL CAPACITY	55 GAL	208.2 L
DRAFT MIN	1' 9"	0.53 M
DRAFT MAX	2' 9"	0.88 M
BEAM ON TRAILER	8' 6"	2.6 M
DRY BOAT WEIGHT W/ STANDARD ENGINE	4,401 LBS	1,996 KG



Specification dimensions are approximate and subject to variance.  
Colors, graphics and some equipment shown, subject to change without notice.

## Standard features

### Electrical

Battery Switch  
Automatic Bilge Pump

### Cockpit

Standard Speakers (4)  
Cup Holders (4)  
Mooring Cleats (6)  
Grab Handles (8)  
Fuel Fill w/ Integrated Vent  
Helm Seat w/ 180 Degree Swivel  
In-Floor Ski/Wakeboard Storage  
Waterproof 120-Watt AM/FM Stereo  
w/ Bluetooth Capability

### Engine

150HP EFI 4 Stroke

### Helm

Multi-Function Gauges w/ Fog Resistant Glass Lenses: Fuel,  
Speedometer, Tachometer, Voltmeter  
12V Horn  
12V Accessory Outlet  
Side-Mounted Engine Controls w/ Trim & Tilt Switch in Handle  
Tilt Steering  
Analog Trim Indicator

### Hull & Deck

Bow & Transom Eyes (3)  
12V Navigation Lights  
Bow Ladder w/ Hinged Lid  
Fiberglass Floor Liner



### Exterior color

- Solid Black hull
- Solid Gray hull
- Solid Blue hull
- Black w/ White bottom
- Blue w/ White bottom

### Interior color

- Coastline (Tan)
- Gray/White



## Optional add-ons

### OB Engines

- 200HP Black Mercury Fourstroke OB Non-DTS
- Power Steering - 175HP and higher O/B

### Floor Covering

- Cockpit Flooring (Gray Mat) ★
- Cockpit Flooring (Teak Mat) ★

### Lighting

- Exterior Lighting (LED Docking Lights, 2x Rear Underwater Lights)

### Trailer

- Tandem Axle Painted Trailer w/Brakes
- Tandem Axle Galvanized Trailer w/Brakes

### Convenience Options

- Digital Depth Indicator ★
- Cockpit Refrigerator
- Full Windshield w/ Opening Control Panel
- Bow Block Off (Req. Bow Filler Cushion)
- Simrad 7" Digital Dash VesselView Link
- Transom Shower
- Portable Head
- Bow Table

## Tower Package

*Includes Standard Features plus:*

- Bow Well and Cockpit Cover
- Snap-On Cover
- Stainless Steel
- Battery Switch-Dual 1/ 2<sup>nd</sup> Tray Single Engine
- ProArc Tower w/ Integrated Top
- Wireless Phone Charger

## Bimini Package

*Includes Standard Features plus:*

- Snap-On Cover
- Stainless Steel
- Bimini Top w/ Boot
- Ski Tow Pylon
- Battery Switch-dual w/ 2<sup>nd</sup> tray single engine

## Comfort Package

*Includes Standard Features plus:*

- Cockpit Table
- Bow Block Off (Req. Bow Filler Cushion)
- Bow Filler Cushion
- Stereo, Rockford Fosgate

## Fishing Package

*Includes Standard Features plus:*

- Bow Casting Platform
- Aerated Live Well
- Fish Finder
- Dual Battery E/24V Plug

★ Popular option

\* CANADA AND INTERNATIONAL ONLY





## Engine performance data

### Outboard

#### 150 HP Mercury I4 FS XL Outboard

Cruise mph	30.2
WOT mph	38.6
Propeller	BlackMax 15.25x15P
Range	144 nm
Weight as tested	5,199 lbs

#### 200 HP Mercury V6 FS XL Outboard

Cruise mph	32.2
WOT mph	44.1
Propeller	Enertia 15x15P
Range	142 nm
Weight as tested	5,244 lbs

*This information is provided for comparison purposes and is intended to show relative performance between different boats and engine options. A specific boat's performance will be affected by water and weather conditions, altitude, condition of boat, actual load, engine and propeller. Engine performance data is based on boat in cruise load weight condition. Cruise load weight condition consists of boat with typical options, full tanks, all safety gear, two passengers and typical storage. Cruising range based on cruise speed at cruise load with 10% fuel reserve at rated range.*

## Features

1. Award winning Mercury engine
2. Premium stitched upholstery
3. Self-bailing cockpit
4. Transitional companion seat w/ sunpad lounging options





# D221

LENGTH OVERALL (LOA)	21' 6"	6.5 M
WIDTH (BEAM)	8' 6"	2.6 M
MAX PEOPLE CAPACITY	11	11
MAX HORSEPOWER	250 HP	250 HP
DEADRISE	18°	18°
MAX PEOPLE WEIGHT	1,552 LBS	704 KG
FUEL CAPACITY	55 GAL	208.2 L
DRAFT MIN	1' 9"	0.53 M
DRAFT MAX	2' 9"	0.88 M
BEAM ON TRAILER	8' 6"	2.6 M



Specification dimensions are approximate and subject to variance.  
Colors, graphics and some equipment shown, subject to change without notice.

## Standard features

### Electrical

- Battery Switch
- Automatic Bilge Pump

### Cockpit

- Standard Speakers (4)
- Cup Holders (4)
- Mooring Cleats (6)
- Grab Handles (8)
- Fuel Fill w/ Integrated Vent
- Helm Seat w/ 180 Degree Swivel
- In-Floor Ski/Wakeboard Storage
- Waterproof 120-Watt AM/FM Stereo w/ Bluetooth Capability

### Engine

- 200 M MPI/ A1 (4.5 L)
- 200 HP MerCruiser ECT 4.5L MPI Sterndrive (Alpha 1 Outdrive)
- ECT CARB COMPLIANT

### Helm

- Multi-Function Gauges w/ Fog Resistant Glass Lenses: Fuel, Speedometer, Tachometer, Voltmeter
- 12V Horn
- 12V Accessory Outlet
- Side-Mounted Engine Controls w/ Trim & Tilt Switch in Handle
- Tilt Steering
- Analog Trim Indicator

### Hull & Deck

- Bow & Transom Eyes (3)
- 12V Navigation Lights
- Bow Ladder w/ Hinged Lid
- Fiberglass Floor Liner
- Swim Platform w/ Telescoping Ladder



# D221



## Exterior color

- Solid Black hull
- Solid Gray hull
- Solid Blue hull

- Black w/ White bottom
- Blue w/ White bottom

## Interior color

- Coastline (Tan)
- Gray/White



## Optional add-ons

### I/O Engines

- 250 HP MerCruiser® ECT 4.5L MPI Sterndrive (Alpha 1 Outdrive)
- High Altitude Prop

### Floor Covering

- Cockpit Flooring (Gray Mat) ★
- Cockpit Flooring (Teak Mat) ★

### Lighting

- Exterior Lighting (LED Docking Lights, 2x Rear Underwater Lights)

### Swim Platforms

- Swim Platform Mat (Gray)
- Swim Platform Mat (Teak)
- Extended Swim Platform Mat (Gray)
- Extended Swim Platform Mat (Teak)
- Swim Platform Extension
- Swim Platform Extension/Color Match/Teak
- Swim Platform Extension/Color Match/Gray

### Convenience Options

- Digital Depth Indicator ★
- Full Windshield w/ Opening Control Panel
- Bow Block Off (Req. Bow Filler Cushion)
- Simrad 7" Digital Dash VesselView Link
- Transom Shower
- Portable Head
- Bow Table
- Cockpit Refrigerator

### Trailer

- Galvanized T/A Trailer w/ Brakes
- Painted T/A Trailer w/ Brakes

## Tower Package

*Includes Standard Features plus:*

- Bow Well and Cockpit Cover
- Snap-On Cover
- Stainless Steel
- Battery Switch-Dual 1/ 2<sup>nd</sup> Tray Single Engine
- ProArc Tower w/ Integrated Top
- Wireless Phone Charger

## Bimini Package

*Includes Standard Features plus:*

- Snap-On Cover
- Stainless Steel
- Bimini Top w/ Boot
- Ski Tow Pylon
- Battery Switch-dual w/ 2<sup>nd</sup> tray single engine

## Comfort Package

*Includes Standard Features plus:*

- Cockpit Table
- Bow Block Off (Req. Bow Filler Cushion)
- Bow Filler Cushion
- Stereo, Rockford Fosgate

★ Popular option

\* CANADA AND INTERNATIONAL ONLY





## Engine performance data

### Sterndrive

#### 200 HP Mercury 4.5L V6 Alpha Sterndrive

Cruise mph	26.2
WOT mph	39.1
Propeller	.Black Max 15x17P
Range	149 nm
Weight as tested	5,479 lbs

#### 250 HP Mercury 4.5L V6 Alpha Sterndrive

Cruise mph	34.4
WOT mph	42
Propeller	.Black Max 15x17P
Range	106 nm
Weight as tested	5,510 lbs

*This information is provided for comparison purposes and is intended to show relative performance between different boats and engine options. A specific boat's performance will be affected by water and weather conditions, altitude, condition of boat, actual load, engine and propeller. Engine performance data is based on boat in cruise load weight condition. Cruise load weight condition consists of boat with typical options, full tanks, all safety gear, two passengers and typical storage. Cruising range based on cruise speed at cruise load with 10% fuel reserve at rated range.*

## Features

1. Award winning Mercury engine
2. Premium upholstery
3. Deep gunnels for a safe, dry ride
4. Transitional seating creating roomy sun lounge area.





# E16

LENGTH OVERALL (LOA)	16' 2"	4.87 M
WIDTH (BEAM)	7' 6"	2.10 M
MAX PEOPLE CAPACITY	6	6
MAX HORSEPOWER	75 HP	75 HP
DEADRISE	17°	17°
APPROX WEIGHT W/ STANDARD ENGINE	1570 LBS	712.14 KG
APPROX WEIGHT W/ TRAILER	2145 LBS	972.95 KG
MAX PEOPLE WEIGHT	850 LBS	385 KG
FUEL CAPACITY	12 GAL	45 L
DRAFT MIN	9"	0.22 M
DRAFT MAX	2' 1"	0.64 M
HEIGHT ON TRAILER <sup>1</sup>	7' 3"	2.1 M
BEAM ON TRAILER	7' 10"	2.13 M
STORAGE LENGTH <sup>2</sup>	19' 3"	5.7 M

 **BAYLINER™**

Specification dimensions are approximate and subject to variance.

<sup>1</sup> Tongue jack lowered all the way down.

<sup>2</sup> Outboard motor in down position and trailer tongue swung to side.

Colors, graphics and some equipment shown, subject to change without notice.

## Features

### Engine

75 HP Mercury® FourStroke ELPT Outboard

### Electrical

Battery Switch  
Automatic Bilge Pump

### Cockpit

Cup Holders  
Grab Handles  
Mooring Cleats

### Trailer

Single Axle Painted Trailer w/ Swing Tongue (Black)  
*Optional* - Single Axle Galvanized trailer upgrade

### Exterior Color

 Black Hull Sides  
(White Bottom)

 Blue Hull Sides  
(White Bottom)

### Interior Color

 White w Gray  
accent

### Helm

Dual Purpose Gauge: Speedometer, Voltmeter  
12V Accessory Outlet  
12V Horn  
Side-Mounted Engine Controls w/ Trim & Tilt Switch in Handle  
Custom Sport Steering Wheel  
Analog Trim Indicator

### Hull & Deck

Bow & Transom Eyes  
12V Navigation Lights  
M-Hull Design  
Fiberglass Floor Liner  
Helm Windscreen  
Swim Platform w/ Telescoping Ladder

### Convenience Package

*Includes Standard Features plus:*

Bimini, 6' Top w/ Boot  
Mooring Cover  
Waterproof 120-Watt AM/FM Stereo w/ Bluetooth Capability

## Optional add-ons

### Options

Ski Tow Arch





# E18

LENGTH OVERALL (LOA)	18' 2"	5.49 M
WIDTH (BEAM)	7' 5"	2.13 M
MAX PEOPLE CAPACITY	9	8
MAX HORSEPOWER	115 HP	115 HP
DEADRISE	17°	17°
APPROX WEIGHT W/ STANDARD ENGINE	2,000 LBS	907 KG
APPROX WEIGHT W/ TRAILER	2,473 LBS	1,122 KG
MAX PEOPLE WEIGHT	1,277 LBS	579 KG
FUEL CAPACITY	12 GAL	45 L
DRAFT MIN	N/A	N/A
DRAFT MAX	2' 5"	0.61 M
HEIGHT ON TRAILER <sup>1</sup>	6' 7"	1.8 M
BEAM ON TRAILER	8' 6"	2.4 M
STORAGE LENGTH <sup>2</sup>	21' 4"	6.4 M



Specification dimensions are approximate and subject to variance.

<sup>1</sup> Tongue jack lowered all the way down.

<sup>2</sup> Outboard motor in down position and trailer tongue swung to side.

Colors, graphics and some equipment shown, subject to change without notice.

## Features

### Engine

115 HP Mercury® FourStroke ELPT Outboard

### Electrical

Battery Switch  
Automatic Bilge Pump

### Cockpit

Cup Holders  
Grab Handles  
Mooring Cleats

### Trailer

Single Axle Painted Trailer w/ Swing Tongue (Black)  
*Optional* - Single Axle Galvanized trailer upgrade

### Exterior Color

● Black Hull Sides  
(White Bottom)

● Blue Hull Sides  
(White Bottom)

### Interior Color

● White w Gray  
accent

### Helm

Dual Purpose Gauge: Speedometer, Voltmeter  
12V Accessory Outlet  
12V Horn  
Side-Mounted Engine Controls w/ Trim & Tilt Switch in Handle  
Custom Sport Steering Wheel  
Analog Trim Indicator

### Hull & Deck

Bow & Transom Eyes  
12V Navigation Lights  
M-Hull Design  
Fiberglass Floor Liner  
Helm Windscreen  
Swim Platform w/ Telescoping Ladder

### Convenience Package

*Includes Standard Features plus:*

Bimini, 6' Top w/ Boot  
Mooring Cover  
Waterproof 120-Watt AM/FM Stereo w/ Bluetooth Capability

## Optional add-ons

### Options

○ Ski Tow Arch

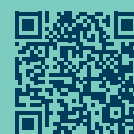



# T18 Bay

LENGTH OVERALL (LOA)	18' 2"	5.5 M
WIDTH (BEAM)	7' 5"	2.3 M
MAX PEOPLE CAPACITY	6	6
MAX HORSEPOWER	115 HP	115 HP
DEADRISE	17°	17°
MAX PEOPLE WEIGHT	992 LBS	424 KG
FUEL CAPACITY	33 GAL	125 L
DRAFT DOWN	2' 7"	0.79 M
BEAM ON TRAILER	8' 6"	2.6 M

**Trophy**

Specification dimensions are approximate and subject to variance.  
Colors, graphics and some equipment shown, subject to change without notice.

## Standard features

### Electrical

Battery Switch  
Automatic Bilge Pump  
Dual Battery w/ 24V Plug

### Cockpit

Cup Holders  
Mooring Cleats (6)  
Grab Handles  
Fuel Fill w/ Integrated Vent  
Flip-Flop Cooler Seat  
Self-Bailing Cockpit

### Engine

115 HP Mercury® Four Stroke

### Helm

Dual Purpose Gauge: Speedometer, Voltmeter  
12V Accessory Outlet  
12V Horn  
Binnacle-Mounted Engine Controls w/ Trim & Tilt Switch in Handle  
Center Console w/ Stainless Steel Steering Wheel  
Mechanical Cable Steering  
Analog Trim Indicator

### Hull & Deck

Bow & Transom Eyes (3)  
12V Navigation Lights  
M-Hull Design for Added Stability  
Fiberglass Floor Liner  
Helm Windscreen  
Integrated trolling motor mount

### Trailer

Single Axle Galv Trailer



# T18 Bay

## Exterior color

- |   |   |   |
|---|---|---|
| <input type="radio"/> Solid White Hull      | <input type="radio"/> Solid Black hull          | <input type="radio"/> White bottom w/ Black hull      |
| <input type="radio"/> Solid Gray hull       | <input type="radio"/> Solid Blue hull           | <input type="radio"/> White bottom w/ Gray hull       |
| <input type="radio"/> Solid Reef Green hull | <input type="radio"/> White bottom w/ Blue hull | <input type="radio"/> White bottom w/ Reef Green hull |

## Interior color

- White

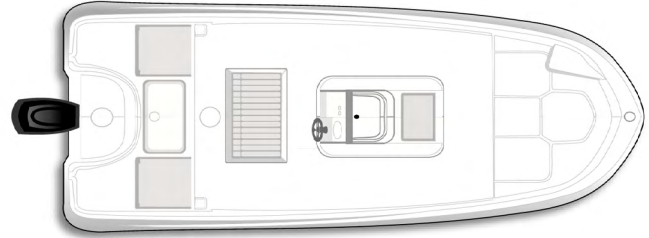

## Optional add-ons

### Engines

- 115 HP Mercury® Four Stroke

### Tops

- T-Top w/ Rail-Mounted Rod Holders (4)

### Swim Platforms

- Port and Starboard Swim Boards w/ Ladder

## Convenience Package

*Includes Standard Features plus:*

- Analog Trim Indicator
- Compass
- Digital Depth Indicator ★
- Waterproof AM/FM Stereo w/ Bluetooth
- VHF Radio w/ Antenna
- Stainless Steel Upgrade
- VHF Radio w/ Antenna
- Waterproof AM/FM Stereo w/Bluetooth
- Hydraulic Steering System
- Forward Livewell
- Trolling Motor Bracket



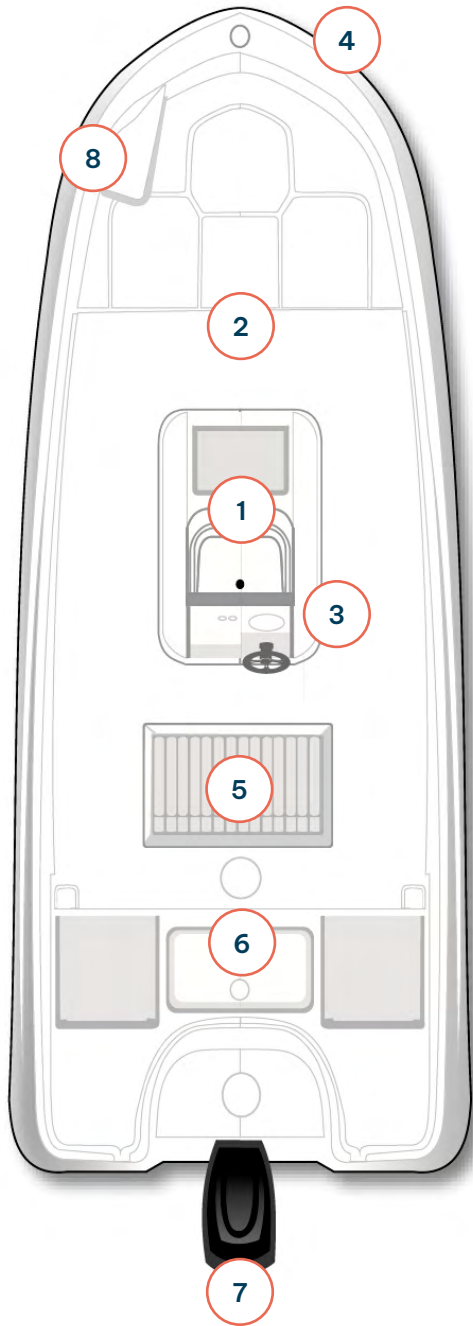

## Features

1. Simple and intuitive helm controls
2. Lightweight model for easy storage, trailering and handling
3. Center Console design for all around casting ease
4. M-Hull design allows for more lateral stability when casting and shallower draft for getting in close
5. Premium stitched upholstery
6. Baitwell/Livewell
7. Award-winning Mercury® engine performance and reliability
8. Large forward casting platform with molded in trolling motor bracket





# T20CC

**Trophy**

LENGTH OVERALL (LOA)	20' 6"	6.10 M
WIDTH (BEAM)	8' 0"	2.43 M
MAX PEOPLE CAPACITY	8	7
MAX HORSEPOWER	175 HP	200 HP
DEADRISE	18°	18°
MAX PEOPLE WEIGHT	1,323 LBS	600 KG
FUEL CAPACITY	55 GAL	208 L
DRAFT MIN	1' 4"	0.41 M
DRAFT MAX	2' 8"	0.61 M
HEIGHT ON TRAILER W/ OPTIONS	8' 11"	2.71 M
BRIDGE CLEARANCE W/ OPTIONS	7' 2"	2.19 M
BEAM	8' 0"	2.43 M
BEAM ON TRAILER	8' 6"	2.6 M
STORAGE LENGTH <sup>1</sup>	22' 2"	6.76 M

Specification dimensions are approximate and subject to variance.  
<sup>1</sup> With trailer/tongue folded  
 Colors, graphics and some equipment shown, subject to change without notice.

## Standard features

### Cockpit

- Self-Bailing Cockpit
- Fuel Fill w/ Integrated Vent
- Waterproof 120-Watt AM/FM Stereo w/ Bluetooth Capability
- Leaning Post
- Battery Switch
- Automatic Bilge Pump
- Removable Cushions
- CC Package - Flip-Up Transom Seats

### Engine

115 HP Mercury® FourStroke EFI Outboard

### Helm

- Multi-Function Gauges w/ Fog Resistant Glass Lenses: Fuel, Speedometer, Tachometer, Voltmeter
- 12V Horn
- Binnacle-Mounted Engine Controls w/ Trim & Tilt Switch in Handle
- Tilt Steering
- Mechanical Throttle and Shift

### Fishing

- Center Console w/ Stainless Steel Steering Wheel
- Leaning Post Livewell
- Insulated Fish Box
- Transom Aerated Livewell - CC Seating Pkg Only

### Steering

Hydraulic Steering System

### Hull & Deck

- Bow & Transom Eyes (3)
- 12V Navigation Lights
- Anchor Locker
- Fiberglass Floor Liner
- Gunnel Rod Holders (4)
- Helm Windscreen
- Port and Starboard Swim Boards w/ Ladder

### Trailer

- Tandem Axle Black Painted or Galvanized Trailer w/Brakes



# T20CC

## Exterior color

- Solid White Hull
- Solid Black hull
- Solid Gray hull
- Solid Blue hull
- Solid Reef Green hull
- White bottom w Black hull
- White bottom w Gray hull
- White bottom w Blue hull
- White bottom w Reef Green hull

## Interior color

- Graphite (Gray)
- Coastline (Tan)

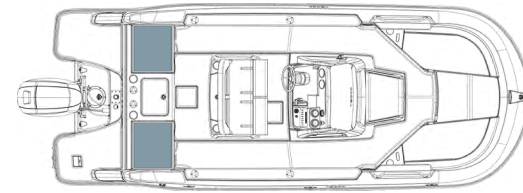

CC  
Flip-Up Transom Seats

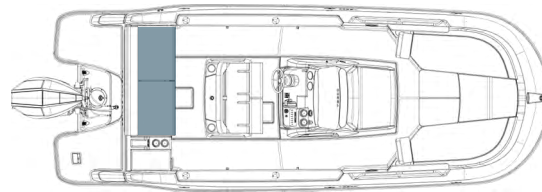

CX  
Transom Cruising Bench Seat

## Optional add-ons

### Engines

- 115 HP 4-Stroke EFI Command Thrust Mercury® Outboard
- 115 HP Mercury® Pro XS XL Outboard
- 150 HP Mercury® FourStroke EFI Outboard
- 175 HP Mercury® Fourstroke ProXS Outboard
- High Altitude Prop

### Steering

- Power Steering – 175 HP and higher, OB

### Tops

- T-Top w/ Rail-Mounted Rod Holders (4)
- Bimini, 6' Top w/ Boot ★

### Canvas

- Snap-On Center Console & Helm Seat Cover ★

### Floor Covering

- Cockpit Flooring (Gray Mat) ★
- Cockpit Flooring (Teak Mat) ★

### Seats & Upholstery

- CC Package - Flip-Up Transom Seats
- CX Package - Transom Cruising Bench Seat, Option Not Available with Current CC Seating Package
- Bow Filler Cushion

### Fishing Accessories

- Dual Battery Trays w/ 24V Plug
- Gunnel Rod Holders

### Appearance Package

- Stainless Package (Fuel Fill, Thru Hull, Horn Vent, Bow Hatch, Latches, Rub Rail)
- Large Trophy Decal Set

### Lighting

- Exterior Lighting (LED Docking Lights, 2x Rear Underwater Lights)
- Interior Lighting

### Water Sports

- Ski Tow Pylon

### Convenience Options

- 7" Glass Dash Screen w/ Engine Data\*
- 9" Glass Dash Screen w/ Engine Data\*
- Twin Simrad 7" Digital Dashes with VesselView® Link
- Twin Simrad 9" Digital Dashes with VesselView® Link
- Transom Shower w/ On-Demand Water System
- Cockpit Table
- Leaning Post
- Digital Depth Indicator ★
- Rockford Fosgate® Stereo System
- Anchor Roller
- Dual Battery Trays w/ Switch
- Raw Water Washdown

★ Popular option

\* Glass Dash options available in dual screen configurations



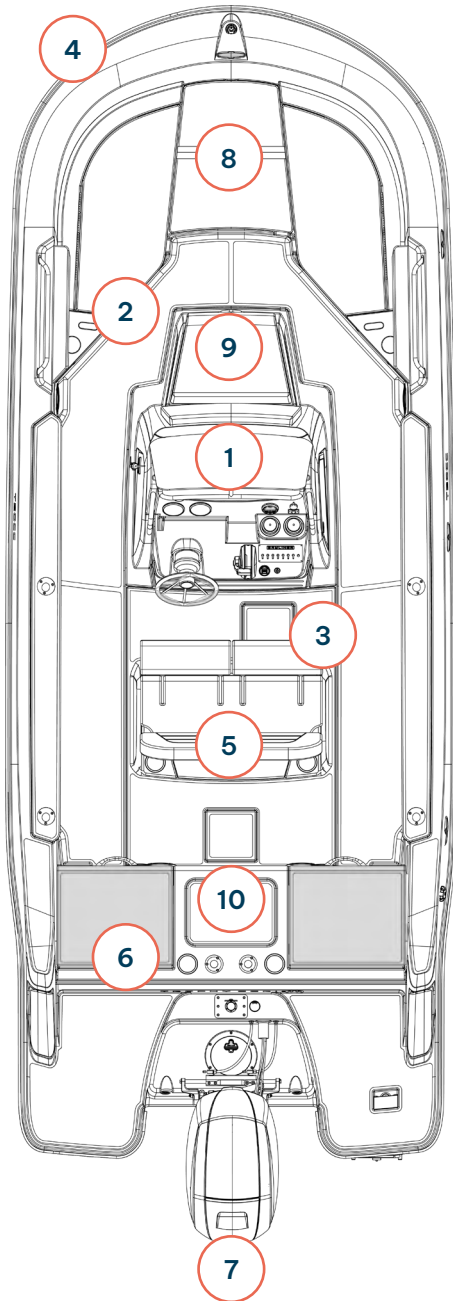

## Features

1. Simple and intuitive helm controls
2. Lightweight model for easy storage, trailering and handling
3. Center console design for all around casting ease
4. V-Hull allows for a smooth ride with higher speed and a dryer ride
5. Premium stitched upholstery
6. Molded-in storage and cup holders
7. Award-winning Mercury® engine performance and reliability
8. Filler cushion turns bow into a sun lounger
9. Built-in forward console storage
10. Integrated livewell/baitwell (CC Package only)





# T22 CC

LENGTH OVERALL (LOA)	22' 7"	6.88 M
WIDTH (BEAM)	8' 6"	2.6 M
MAX PEOPLE CAPACITY	10	8
MAX HORSEPOWER	300 HP	300 HP
DEADRISE	18°	18°
MAX PEOPLE WEIGHT	1,654 LBS	750 KG
FUEL CAPACITY	65 GAL	246 L
DRAFT MIN	1' 4"	0.41 M
DRAFT MAX	3' 1"	0.93 M
BEAM ON TRAILER	8' 6"	2.6 M

**Trophy**

Specification dimensions are approximate and subject to variance.

<sup>1</sup> Tongue jack lowered all the way down.

<sup>2</sup> Stern drive in down position and trailer tongue swung to side.

Colors, graphics and some equipment shown, subject to change without notice.

## Standard features

### Electrical

Battery switch  
Automatic Bilge Pump

### Cockpit

Self-Bailing Cockpit  
Fuel Fill w/ Integrated Vent  
Waterproof 120-Watt AM/FM Stereo w/  
Bluetooth Capability  
Leaning Post  
Removable Cushions  
CC Package - Flip-Up Transom Seats

### Fishing

Center Console w/ Stainless Steel Steering  
Wheel  
Leaning Post w/ Livewell  
Aerated Livewell, CC  
Insulated Fish Box

### Engine

150 HP Mercury® FourStroke EFI Outboard

### Helm

Multi-Function Gauges w/ Fog Resistant Glass Lenses: Fuel, Speedometer,  
Tachometer, Voltmeter  
12V Horn  
Binnacle-Mounted Engine Controls w/ Trim & Tilt Switch in Handle  
Tilt Steering  
Mechanical Throttle and Shift

### Hull & Deck

Bow & Transom Eyes (3)  
12V Navigation Lights  
Anchor Locker  
Fiberglass Floor Liner  
Gunnel Rod Holders (4)  
Helm Windscreen  
Port and Starboard Swim Boards w/ Ladder

### Trailer

Tandem Axle Painted or Galvanized Trailer w/Brakes



## Exterior color

- Solid White Hull
- Solid Black hull
- Solid Gray hull
- Solid Blue hull
- Solid Reef Green hull
- White bottom w/ Black hull
- White bottom w/ Gray hull
- White bottom w/ Blue hull
- White bottom w/ Reef Green hull

## Interior color

- Graphite (Gray)
- Coastline (Tan)

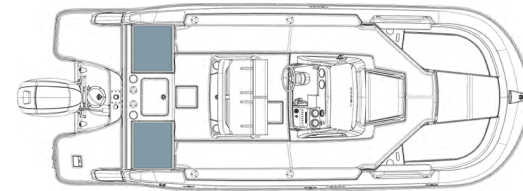

CC  
Flip-Up Transom Seats

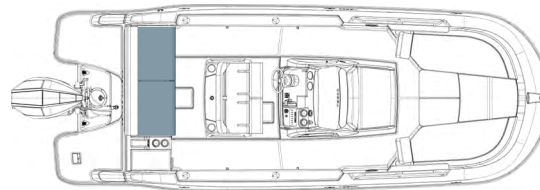

CX  
Transom Cruising Bench Seat

## Optional add-ons

### OB Engines

- 175 HP Mercury® Fourstroke ProXS Outboard
- 200 HP Mercury® FourStroke Outboard Non-DTS (Black)
- 250 HP Black Mercury® OB Non-DTS (Black)
- 300 HP Black Mercury® Verado® OB
- High Altitude Prop
- Pre-rig for V6 Mercury® DTS
- Pre-rig, Blank V8 Mercury® DTS
- Warm Fusion White Options Available as Applicable

### Steering

- Power Steering – 175 HP and higher

### Tops

- T-Top w/ Rail-Mounted Rod Holders (4)
- Bimini, 6' Top w/ Boot ★

### Canvas

- Snap-On Center Console & Helm Seat Cover ★

### Floor Covering

- Cockpit Flooring (Gray Mat) ★
- Cockpit Flooring (Teak Mat) ★

### Seats & Upholstery

- CC Package - Flip-Up Transom Seats
- CX Package - Transom Cruising Bench Seat
- Bow Filler Cushion

### Fishing Accessories

- Dual Battery Trays w/ 24V Plug
- Gunnel Rod Holders (4)

### Appearance Package

- Stainless Package (Fuel Fill, Thru Hull, Horn Vent, Bow Hatch, Latches, Rub Rail)

### Lighting Package

- Exterior Lighting (LED Docking Lights, 2x Rear Underwater Lights)
- Interior Lighting Package

### Water Sports

- Ski Tow Pylon

### Convenience Options

- 7" Glass Dash Screen w/ Engine Data\*
- 9" Glass Dash Screen w/ Engine Data\*
- Twin Simrad 7" Digital Dashes with VesselView® Link
- Twin Simrad 9" Digital Dashes with VesselView® Link
- Transom Shower w/ On-Demand Water System
- Bilge Pump (Automatic) ★
- Cockpit Table
- Digital Depth Indicator ★
- Portable Head
- Raw Water Washdown
- Anchor Roller
- Dual Battery Trays w/ Switch
- Rockford Fosgate® Stereo Upgrade
- Leaning Post

★ Popular option

\* Glass Dash options available in dual screen configurations



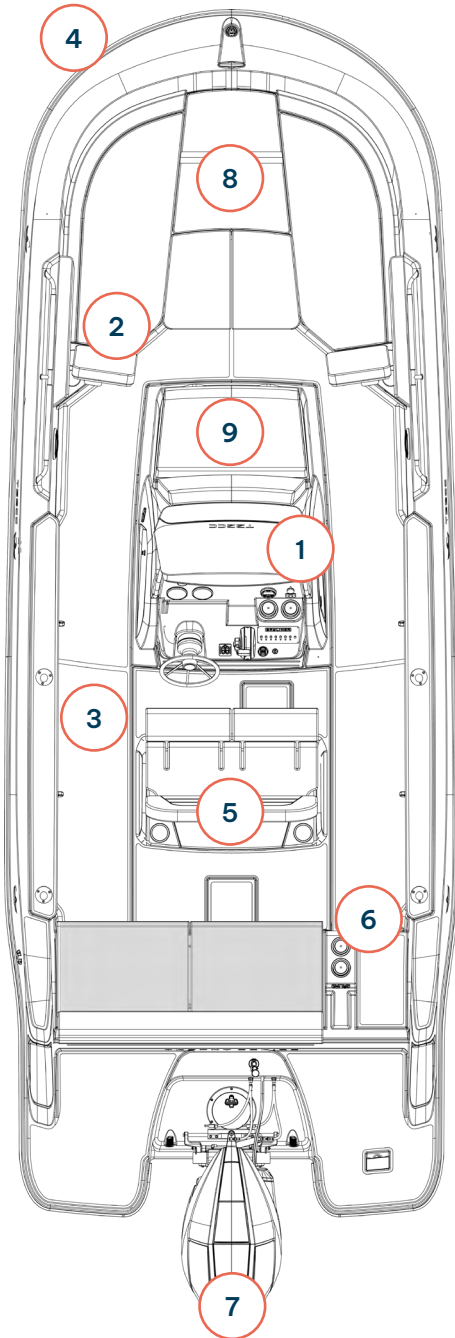

## Features

1. Simple and intuitive helm controls
2. Lightweight model for easy storage, trailering and handling
3. Center console design for all around fishing ease
4. V-Hull allows for a smooth ride with higher speed and near shore performance
5. Premium stitched upholstery
6. Molded-in storage and cup holders
7. Award-winning Mercury® engine performance and reliability
8. Filler cushion turns bow into a sun lounger
9. Built-in forward console storage





# T24 CC

**Trophy**

LENGTH OVERALL (LOA)	24' 7"	7.49 M
WIDTH (BEAM)	8' 6"	2.6 M
MAX PEOPLE CAPACITY	12	12
MAX HORSEPOWER	300 HP	300 HP
DEADRISE	22°	22°
APPROX WEIGHT W/ STANDARD ENGINE	4,466 LBS	2,026 KG
APPROX WEIGHT W/ TRAILER	6,115 LBS	2,774 KG
MAX PEOPLE WEIGHT	1,984 LBS	900 KG
FUEL CAPACITY	100 GAL	378.5 L
DRAFT MIN	1' 6"	0.46 M
DRAFT MAX	2' 11"	0.89 M
STORAGE HEIGHT <sup>1</sup>	11' 2"	3.4 M
BEAM ON TRAILER	8' 6"	2.6 M
STORAGE LENGTH <sup>2</sup>	32' 10"	10.0 M

Specification dimensions are approximate and subject to variance.

<sup>1</sup> With trailer/tower folded

<sup>2</sup> Outboard motor in down position and trailer tongue swung to side.

Colors, graphics and some equipment shown, subject to change without notice.

## Standard features

### Steering

Hydraulic Steering System

### Cockpit

Self-Bailing Cockpit  
Raw Water Washdown  
Fuel Fill w/ Integrated Vent  
Waterproof 120-Watt AM/FM Stereo  
w/ Bluetooth® Capability  
Leaning Post w/ Livewell  
Dual Batteries w/ Switch  
Automatic Bilge Pump  
Removable Bow Backrests and Cushions  
Fold-Away Rear Bench Seat  
Canvas T-Top w/ Rod Holders (4)  
CC Fishing Seats w/ Livewell

### Fishing

Center Console w/ Stainless Steel Steering Wheel  
15-Gal Baitwell  
21-Gal Leaning Post Livewell  
6-Ft Dual Insulated Fish Boxes  
Under Gunnel Rod Storage  
Gunnel Rod Holders (4)

### Engine

225 XXL Fourstroke OB Non-DTS (Black)

### Helm

Multi-Function Gauges w/ Fog-Resistant Glass Lenses: Fuel,  
Speedometer, Tachometer, Voltmeter  
12V Horn  
Binnacle-Mounted Engine Controls w/ Trim & Tilt Switch in Handle  
Tilt Steering  
Mechanical Throttle & Shift  
Console Storage

### Hull & Deck

Bow & Transom Eyes (3)  
12V Navigation Lights  
Anchor Locker  
Fiberglass Floor Liner  
Helm Windshield  
Port and Starboard Swim Boards w/ Ladder  
Stainless Steel Cleats (6)



## Exterior color

- Solid White hull
- Solid Black hull
- Solid Gray hull
- Solid Blue hull
- Solid Reef Green hull
- White bottom w/ Black hull
- White bottom w/ Gray hull
- White bottom w/ Blue hull
- White bottom w/ Reef Green hull

## Interior color

- Graphite (Gray)
- Coastline (Tan)



## Optional add-ons

### OB Engines

- 250 HP XXL Mercury® FourStroke Outboard Non-DTS
- 300 HP XXL Mercury® V8 AMS Outboard (Includes Power-Assisted Steering)
- High Altitude Prop
- Pre-Rig Blank V6 Mercury® DTS
- Pre-Rig Blank V8 Mercury® DTS For 250 HP
- Pre-Rig Blank V8 Mercury® DTS For 300 HP
- Warm Fusion White Options Available as Applicable

### Steering

- Power Steering – 175 HP & Higher (Outboard Only)
- Power Steering – 300 HP AMS
- Premium Steering Wheel w/ Knob ★

### Tops

- Fiberglass Hardtop w/ Spreader Lights

### Canvas

- Snap-On Center Console & Helm Seat Cover ★

### Floor Covering

- Cockpit Flooring (Gray Mat) ★
- Cockpit Flooring (Teak Mat) ★

### Seats & Upholstery

- Bow Filler Cushion
- Premium Leaning Post w/ Bolsters (Premium Helm Seat w/ Fold up Bolsters, Integrated Livewell And Clear Acrylic Livewell Lid)
- Leaning Post (Base Leaning Post minus Livewell and Seat Bolsters)

### Fishing Accessories

- Trolling Motor Bracket w/ 24V Plug
- Trolling Motor Pre-Rig w/ 24V Plug
- Dual Fishwell Macerator
- Pumps and Smartcraft Gauge

### Water Sport

- Ski Tow Pylon

### Appearance Package

- Stainless Package (Fuel Fill, Thru Hull, Horn Vent, Bow Hatch, Latches, Rub Rail) ★
- 6" Forward, Mid & Aft Pop Up Cleats

### Lighting

- Exterior Lighting (LED Docking Lights, 2x Rear Underwater Lights)
- Interior Lighting

### Convenience Options

- Simrad 9" Digital Dash\* with VesselView® Link
- Twin Simrad 9" Digital Dashes with VesselView® Link
- Cockpit Table
- Digital Depth Indicator ★
- Portable Head
- Freshwater Shower (10-Gal Tank)
- Anchor Roller
- Trims Tabs
- Windlass
- Dual Battery Trays w/ Switch ★
- 25-qt Carry-On Cooler
- Rockford Fosgate® System (4 Speaker)
- VHF Radio w/ Antenna
- Blank Dash Option
- CX Package – Transom Cruising Bench Seat
- SmartCraft SC1000 Gauge (Speed & Tach)
- Dual Fishwell Macerator Pumps

### Trailer

- Tandem Axle Aluminum Trailer w/ Brakes & Swing Tongue

★ Popular option

\* 9" Digital Dash Available in Twin Configuration





## Engine performance data

### Outboard

#### Mercury 250 Four Stroke

Cruise mph	27.6
WOT mph	45.8
Propeller	Enertia 14.5 x 17 x 3 BL
Range	239 nm
Weight as tested	5,778 lbs

#### Mercury 300 Verado

Cruise mph	22.4
WOT mph	49.7
Propeller	Enertia 14 x 19 x 3 BL
Range	266 nm
Weight as tested	5,778 lbs

*This information is provided for comparison purposes and is intended to show relative performance between different boats and engine options. A specific boat's performance will be affected by water and weather conditions, altitude, condition of boat, actual load, engine and propeller. Engine performance data is based on boat in cruise load weight condition. Cruise load weight condition consists of boat with typical options, full tanks, all safety gear, two passengers and typical storage. Cruising range based on cruise speed at cruise load with 10% fuel reserve at rated range.*

## Features

1. Simple and intuitive helm controls w/ molded in cupholders and chuck storage
2. Center console design for ease of casting and fishing
3. Deep V-Hull allows for a smooth and dry ride in deeper waters
4. Premium stitched upholstery
5. Molded-in storage and cup holders
6. Award-winning Mercury® engine performance and reliability
7. Filler cushion turns bow into a sun lounger
8. Built-in livewell in standard CC configuration
9. Large in-floor fish lockers
10. Built-in forward console storage





LENGTH OVERALL (LOA)	22' 7"	7.3 M
WIDTH (BEAM)	8' 6"	2.6 M
MAX PEOPLE CAPACITY	10	10
MAX HORSEPOWER	250 HP	250 HP
DEADRISE	18°	18°
APPROX WEIGHT W/ STANDARD ENGINE	4,500 LBS	2,041.2 KG
MAX PEOPLE WEIGHT	1,650 LBS	748.4 KG
FUEL CAPACITY	80 GAL	302.8 L
DRAFT MIN	1' 10"	0.56 M
DRAFT MAX	2' 9"	0.88 M
STORAGE HEIGHT <sup>1</sup>	6' 4"	1.9 M
BEAM ON TRAILER	8' 6"	2.6 M
LENGTH W/ TRAILER	24'	7.3 M

# T22SC

**Trophy**

Specification dimensions are approximate and subject to variance.  
<sup>1</sup> With trailer/tower folded  
 Colors, graphics and some equipment shown, subject to change without notice.

## Standard features

### Electrical

Battery Switch  
 Automatic Bilge Pump

### Cockpit

Self-Bailing Cockpit  
 Fuel-Fill w/ Intergrated Vent  
 Waterproof 120-Watt AM/FM Stereo w/Bluetooth  
 Removeable Cushions  
 Forward Console Bench Seating w/ backrest  
 Cupholders (8)  
 Side Console Storage

### Fishing

Livewell  
 Gunnel Rod Storage  
 Insulated Fish Box

### Engine

150 HP EFI 4 Stroke Mercury OB

### Helm

Multi-Function Gauges w/ Fog Resistant Glass Lenses: Fuel, Speedometer,  
 Tachometer, Voltmeter  
 12V Horn  
 Helm Windshield  
 Stainless Steel Steering Wheel

### Hull & Deck

Swim Platform w/ Telescoping Ladder  
 Anchor Locker  
 Fiberglass Floor Liner  
 Bow & Transom Eyes (3)  
 Navigation Lights

### Trailer

Galvanized Trailer w/ Brakes

### Exterior color

- White bottom w/ Black hull
- White bottom w/ Gray hull
- White bottom w/ Blue hull

### Interior color

- Graphite (Gray)
- Coastline (Tan)



## Optional add-ons

### OB Engines

- 200 HP Mercury FourStroke Outboard Warm Fusion White Non-DTS
- 250 HP Mercury FourStroke Black Non-DTS
- 250 HP Mercury FourStroke Outboard Warm Fusion Non-
- Power Steering – 175HP and higher O/B Only
- Trim Tabs
- High Altitude Prop

### Canvas

- Snap-On Center Console & Helm Seat Cover ★
- Deluxe Travel Cover
- Bow Well and Cockpit Cover

### Floor Covering

- Cockpit Flooring (Gray Mat) ★
- Cockpit Flooring (Teak Mat) ★

### Lighting

- Exterior Lighting (LED Docking Lights, 2x Rear Underwater Lights)
- Interior Lighting

### Trailer

- Tandem Blk Axle Trailer w/Brakes

### Convenience Options

- Digital Depth Indicator
- Simrad 7" Digital Dash w/ VesselView® Link
- Simrad 9" Digital Dash w/ VesselView Link
- Twin Simrad 7" Digital dash w/ Vesselview Link
- Twin Simrad 9" Digital Dash w/ VesselView Link

### Fishing Accessories

- Trolling Motor Prerig 24V

## Fishing Package

*Includes Standard Features plus:*

- Trolling Motor Bracket w/ 24V Plug
- Fresh Water Washdown
- Steering Wheel w/ Knob
- Bow Casting Seat

## Bimini Package

*Includes Standard Features plus:*

- Stainless Steel Upgrade
- Bimini Top w/ Boot
- Windshield Wiper (Starboard)

## Comfort Package

*Includes Standard Features plus:*

- Cockpit Table
- Bow Block Off (Req. Bow Filler Cushion)
- Bow Filler Cushion
- Portable Head

## Tech Package

*Includes Standard Features plus:*

- Exterior Lighting Package
- Stereo, Rockford Fosgate
- Interior Lighting Package
- Dual Vessel Batteries w/ Switch

★ Popular option

\* 9" Digital Dash Available in Twin Configuration



## Engine performance data

### Outboard

#### 150 HP Mercury FS XL Outboard

Cruise mph	27.3
WOT mph	36
Propeller	Enertia 15.3x14P
Range	206 nm
Weight as tested	5,464 lbs

#### 200 HP Mercury V6 FS XL Outboard

Cruise mph	30.7
WOT mph	39.6
Propeller	Enertia 15x15P
Range	227 nm
Weight as tested	5,594 lbs

#### 250 HP Mercury V8 FS XL Outboard

Cruise mph	31.7
WOT mph	44.3
Propeller	Enertia 15x15P
Range	191 nm
Weight as tested	5,624 lbs

*This information is provided for comparison purposes and is intended to show relative performance between different boats and engine options. A specific boat's performance will be affected by water and weather conditions, altitude, condition of boat, actual load, engine and propeller. Engine performance data is based on boat in cruise load weight condition. Cruise load weight condition consists of boat with typical options, full tanks, all safety gear, two passengers and typical storage. Cruising range based on cruise speed at cruise load with 10% fuel reserve at rated range.*

## Features

1. Premium Forward Console Bench Seating
2. Award Winning Mercury Engine
3. Console Storage
4. Gunnel Rod Storage



# T23 Explorer

LENGTH OVERALL (LOA)	24' 2"	7.37 M
WIDTH (BEAM)	8' 4"	2.54 M
MAX PEOPLE CAPACITY	9	9
MAX HORSEPOWER	225 HP	225 HP
DEADRISE	16°	16°
APPROX WEIGHT W/ STANDARD ENGINE	4,075 LBS	1,848 KG
MAX LOAD WEIGHT	2,350 LBS	1,066 KG
FUEL CAPACITY	53 GAL	200 L
WATER CAPACITY	11.8 GAL	45 L
DRAFT MIN	1' 7"	0.48 M
DRAFT MAX	3'	0.91 M
HEIGHT <sup>1</sup>	9' 2"	2.79 M
HEIGHT <sup>1</sup> W/ OPTIONS	9' 5"	2.87 M

Specification dimensions are approximate and subject to variance.

<sup>1</sup> With trailer/tower folded

<sup>2</sup> Outboard motor in down position and trailer tongue swung to side.

Colors, graphics and some equipment shown, subject to change without notice.

## Trophy

## Standard features

### Cockpit

- Cockpit Sun Lounge
- Aft Bench Seat
- Storage below Aft Seat
- Aft Seat Extension L-Lounge
- Cockpit Cushions
- Real teak cockpit table
- Cockpit Shower
- Transom Door

### Equipment

- Stereo Fusion with 4 speakers
- Active Trim
- Dual Battery System
- CO Monitor
- Smoke Detector
- Electric & Manual Bilge Pump
- Starboard Windshield Wiper
- Windshield Wash
- OB Pre-Rigging
- Bimini with Enclosed Canvas

### Engine

150HP Mercury FourStroke EFI Outboard

### Steering

Hydraulic Steering System

### Helm

- SmartCraft Speedometer/
- Tachometer
- 12v Electrical Socket

### Hull & Deck

- Bow Roller
- Swim Ladder
- Navigation Lights
- Forward Line/Anchor Locker
- Self Bailing Cockpit
- Rod holders
- Swim Platforms
- Swim Platform Extensions
- Hull Color (White)
- LED Courtesy lights

### Cabin

- Storage below Berth
- Pilot Seats with Flip Bolster and Swivel
- Dinette Seat Configuration
- Berth Cushion/Filler
- Deck Hatch
- Sink with Tap



# T23 Explorer



## Optional add-ons

### Engines

- Mercury 225 V6
- Mercury 175HP XL V6

### Cabin Comfort Pack

- Enclosed sea toilet with sink
- Curtains
- Refrigerator 51L

### Floor Covering

- Flexiteek Flooring

### Convenience Options

- Simrad GPS/Chart Plotter 9" NSS evo3s with HDI Transducer & VesselView Link Digital Interface
- Simrad VHF RS20
- Bow Thruster
- Diesel Heating
- Bow Electrical Windlass
- Wallas stove
- Roof Hatch
- Forward Sun Lounge

## Features

1. Award winning Mercury engine
2. Premium stitched upholstery
3. Enclosed cabin
4. Galley sink w/ tap
5. Foredeck w/ opening hatch
6. Sliding cabin entry door
7. Versatile cockpit area



# T23 Explorer



## Engine performance data

### Outboard

#### 175 HP Mercury V6 FS XL

Cruise mph	21.3
WOT mph	38.5
Propeller	Enertia 15.3x14P
Range	163 nm
Weight as tested	4,625 lbs

#### 225 HP Mercury V6 FS XL

Cruise mph	20.3
WOT mph	40.7
Propeller	Enertia 15.3x14P
Range	168 nm
Weight as tested	4,625 lbs

*This information is provided for comparison purposes and is intended to show relative performance between different boats and engine options. A specific boat's performance will be affected by water and weather conditions, altitude, condition of boat, actual load, engine and propeller. Engine performance data is based on boat in cruise load weight condition. Cruise load weight condition consists of boat with typical options, full tanks, all safety gear, two passengers and typical storage. Cruising range based on cruise speed at cruise load with 10% fuel reserve at rated range.*





# T25 Explorer

**Trophy**

LENGTH OVERALL (LOA)	25' 6"	7.76 M
WIDTH (BEAM)	9' 4"	2.84 M
MAX PEOPLE CAPACITY	11	11
MAX HORSEPOWER	300 HP	300 HP
DEADRISE	17°	17°
APPROX WEIGHT W/ STANDARD ENGINE	5,189 LBS	2,354 KG
MAX LOAD WEIGHT	2,650 LBS	1,020 KG
FUEL CAPACITY	74 GAL	280 L
WATER CAPACITY	21.1 GAL	79 L
DRAFT MIN	1' 8"	0.51 M
DRAFT MAX	3' 1"	0.94 M
HEIGHT <sup>1</sup>	9' 8"	2.94 M
HEIGHT <sup>1</sup> W/ OPTIONS	10' 10"	3.30 M

Specification dimensions are approximate and subject to variance.

<sup>1</sup> With trailer/tower folded

<sup>2</sup> Outboard motor in down position and trailer tongue swung to side.

Colors, graphics and some equipment shown, subject to change without notice.

## Standard features

### Cockpit

- Cockpit Sun Lounge
- Aft Bench Seat
- Storage below Aft Seat
- Aft Seat Extension L-Lounge
- Cockpit Cushions
- Cockpit Shower
- Transom Door
- Upgraded Cockpit Table
- Cockpit Lighting

### Equipment

- Shore Power 110v
- Stereo Fusion with 6 speakers
- Active Trim
- Bow Thruster
- City Water Inlet
- Dual Battery System
- CO Monitor
- Smoke Detector
- Electric & Manual Bilge Pump
- Electric Trim Tabs
- Starboard Windshield Wiper
- Port Windshield Wiper
- Windshield Wash
- OB Pre-Rigging
- Bimini with Enclosed Canvas

### Engine

Mercury 225 V6

### Steering

Hydraulic Steering System  
Power Steering

### Helm

SmartCraft Speedometer/  
Tachometer  
12v Electrical Socket  
Adjustable Steering Position

### Hull & Deck

Bow Roller  
Swim Ladder  
Navigation Lights  
Forward Line/Anchor Locker  
Self Bailing Cockpit  
Rod holders  
Swim Platforms  
Swim Platform Extensions  
Hull Color (White)  
LED Courtesy lights  
Hull side windows

### Cabin

Berth (4)  
Storage below Berth  
Pilot Seats with Flip Bolster and Swivel  
Dinette Seat Configuration  
Berth Cushion/Filler  
Deck Hatch  
Opening Portlights  
Sink with Tap  
Enclosed Sea toilet  
Opening Portlight



# T25 Explorer



## Optional add-ons

### Engines

- Mercury 300 V8 Verado

### Cabin Comfort Pack

- Refrigerator 51L
- Hardtop Roof hatch
- Foredeck & Hardtop Hatch Cover – (roller surface: blackout/flyscreen)
- Upper and lower cabin curtains

### Floor Covering

- Flexiteek Flooring

### Seats & Upholstery

- Aft Seat Folding Backrest

### Convenience Options

- Simrad GPS/Chart Plotter 9”NSS evo3s with HDI Transducer & VesselView Link Digital Interface
- Simrad VHF RS20
- Bow Thruster
- Diesel Heating
- Bow Electrical Windlass
- Wallas stove
- Forward Sun Lounge
- Single air conditioning/heating with battery bank

## Features

1. Award winning Mercury engine
2. Premium stitched upholstery
3. Spacious dining area
4. Adjustable steering position
5. Transom door
6. Additional storage below aft seat
7. Aft seat extension L-lounge



# T25 Explorer



## Engine performance data

### Outboard

#### 225 HP Mercury V6 FS XL

Cruise mph	21.3
WOT mph	38.5
Propeller	Enertia 15.3x14P
Range	163 nm
Weight as tested	5,939 lbs

#### 300 HP Mercury V8 FS XL

Cruise mph	20.5
WOT mph	39.2
Propeller	Enertia 14.5x17P
Range	163 nm
Weight as tested	6,002 lbs

*This information is provided for comparison purposes and is intended to show relative performance between different boats and engine options. A specific boat's performance will be affected by water and weather conditions, altitude, condition of boat, actual load, engine and propeller. Engine performance data is based on boat in cruise load weight condition. Cruise load weight condition consists of boat with typical options, full tanks, all safety gear, two passengers and typical storage. Cruising range based on cruise speed at cruise load with 10% fuel reserve at rated range.*





# T29 Explorer

**Trophy**

LENGTH OVERALL (LOA)	29' 10"	9.09 M
WIDTH (BEAM)	9' 9"	2.97 M
MAX HORSEPOWER	450 HP	450 HP
DEADRISE	17°	17°
APPROX WEIGHT W/ STANDARD ENGINE	6,508 LBS	2,951 KG
FUEL CAPACITY	126 GAL	476 L
WATER CAPACITY	26.4 GAL	100 L
DRAFT MIN	2' 1"	0.64 M
DRAFT MAX	3' 7"	1.09 M
HEIGHT <sup>1</sup>	11' 4"	3.45 M
HEIGHT <sup>1</sup> W/ OPTIONS	12' 3"	3.73 M

Specification dimensions are approximate and subject to variance.

<sup>1</sup> With trailer/tower folded

<sup>2</sup> Outboard motor in down position and trailer tongue swung to side.

Colors, graphics and some equipment shown, subject to change without notice.

## Standard features

### Cockpit

Cockpit Sun Lounge  
Aft Bench Seat  
Aft Seat Folding Backrest  
Storage below Aft Seat  
Aft Seat Extension L-Lounge  
Cockpit Cushions  
Transom Door  
Upgraded Cockpit Table

### Equipment

Shore Power 110v  
Stereo Fusion with 6 speakers  
Simrad GPS/Chart Plotter  
9" NSS evo3s with HDI Transducer  
& VesselView Link Digital Interface  
Active Trim  
Bow Thruster  
City Water Inlet  
Dual Battery System  
CO Monitor  
Smoke Detector  
Electric & Manual Bilge Pump  
Electric Trim Tabs  
Starboard Windshield Wiper  
Port Windshield Wiper

Windshield Wash  
OB Pre-Rigging  
Spotlight  
Bimini with Enclosed Canvas  
Interior TV bracket  
Rooftop Hatch

### Engine

2x Mercury 225 V6

### Steering

Hydraulic Steering System

### Helm

SmartCraft Speedometer/  
Tachometer  
12v Electrical Socket

### Hull & Deck

Bow Roller  
Swim Ladder  
Navigation Lights  
Forward Line/Anchor Locker  
Self Bailing Cockpit  
Rod Holders

Swim Platforms  
Swim Platform Extensions  
Hull Color (White)  
LED Courtesy Lights  
Hull Side Windows  
Bow Electrical Windlass

### Cabin

Berth (5)  
Storage below Berth  
Pilot Seats with Flip Bolster  
and Swivel  
Dinette Seat Configuration  
Berth Cushion/Filler  
Deck Hatch  
Opening Portlights  
Shower  
Sink with Tap  
Enclosed Sea toilet  
Opening Portlight  
Roof Hatch  
Hatch Screen Cover  
Microwave prerig only



# T29 Explorer



## Optional add-ons

### Engines

- Twin 225 XL V6 DTS
- SC & Hyd/Electric Power Steering

### Cabin Comfort Pack

- Curtains
- Refrigerator 51L
- Interior floor carpet

### Floor Covering

- Flexiteek Flooring

### Lighting

- Cockpit Lighting

### Convenience Options

- Simrad VHF RS20
- Simrad HALO20 Radar
- Diesel Heating
- Wallas stove
- Forward Sun Lounge
- Single Air Conditioning/Heating with Battery Bank
- Cockpit Shower
- Diesel Generator w/Cabin Air Conditioning (120v/60Hz)

## Features

1. Award winning Mercury engine
2. Premium stitched upholstery
3. Yacht Certified
4. Spacious Dinette Seat Configuration
5. Sliding aft seat
6. Seat extension L-lounge
7. Sliding side entry door
8. Galley



# T29 Explorer



## Engine performance data

### Outboard

#### Twin 225 Mercury V6 FS XL

Cruise mph	25.7
WOT mph	45.5
Propeller	Enertia 14.5x17P
Range	218 nm
Weight as tested	7,280 lbs

*This information is provided for comparison purposes and is intended to show relative performance between different boats and engine options. A specific boat's performance will be affected by water and weather conditions, altitude, condition of boat, actual load, engine and propeller. Engine performance data is based on boat in cruise load weight condition. Cruise load weight condition consists of boat with typical options, full tanks, all safety gear, two passengers and typical storage. Cruising range based on cruise speed at cruise load with 10% fuel reserve at rated range.*





# T23 Pilothouse

LENGTH OVERALL (LOA)	23' 7"	7.18 M
WIDTH (BEAM)	8' 6"	2.6 M
MAX PEOPLE CAPACITY	9	9
MAX HORSEPOWER	225 HP	225 HP
DEADRISE	17°	17°
APPROX WEIGHT W/ STANDARD ENGINE	4,071 LBS	1,846 KG
MAX PEOPLE WEIGHT	1,500 LBS	680 KG
FUEL CAPACITY	51 GAL	193 L
DRAFT MIN	1' 9"	0.53 M
DRAFT MAX	3'	0.91 M
HEIGHT1	9' 2"	2.79 M
HEIGHT1 W/ OPTIONS	10' 5"	3.17 M

Specification dimensions are approximate and subject to variance.

<sup>1</sup> With trailer/tower folded

<sup>2</sup> Outboard motor in down position and trailer tongue swung to side.

Colors, graphics and some equipment shown, subject to change without notice.

**Trophy**

## Standard features

### Cockpit

Cockpit Rod Storage  
Rod holders  
Self Bailing Cockpit  
Transom Door  
Cockpit Flood Light

### Equipment

CO Monitor  
VesselView Mobile  
Active Trim  
Smoke Detector  
Electric & Manual Bilge Pump  
Starboard Windshield Wiper  
OB Pre-Rigging  
Dual Battery System

### Engine

Mercury 175 V6

### Steering

Hydraulic Steering  
Tilt Steering

### Helm

Smartcraft Speedometer/Tachometer  
12v Electrical Socket

### Hull & Deck

Swim Ladder  
Swim Platform  
Anchor Locker  
Navigation Lights

### Cabin

Storage below Berth  
Cabin Lights  
Pilot & Co-pilot Seat  
Starboard Pilothouse Entry Door  
Portside Pilothouse Entry Door

### Seats & Upholstery

Aft Flip Seats & Table  
Bow Cushion

### USA Premium Package

Black Bow Railing with Fender Holders  
Swim Platform Extension  
Bow Roller  
Rocket Launcher Rod Holders & Black Roof Rack  
Cockpit Shower  
Roof Hatch  
Sink with Tap  
Stereo Fusion with 4 speakers



# T23 Pilothouse

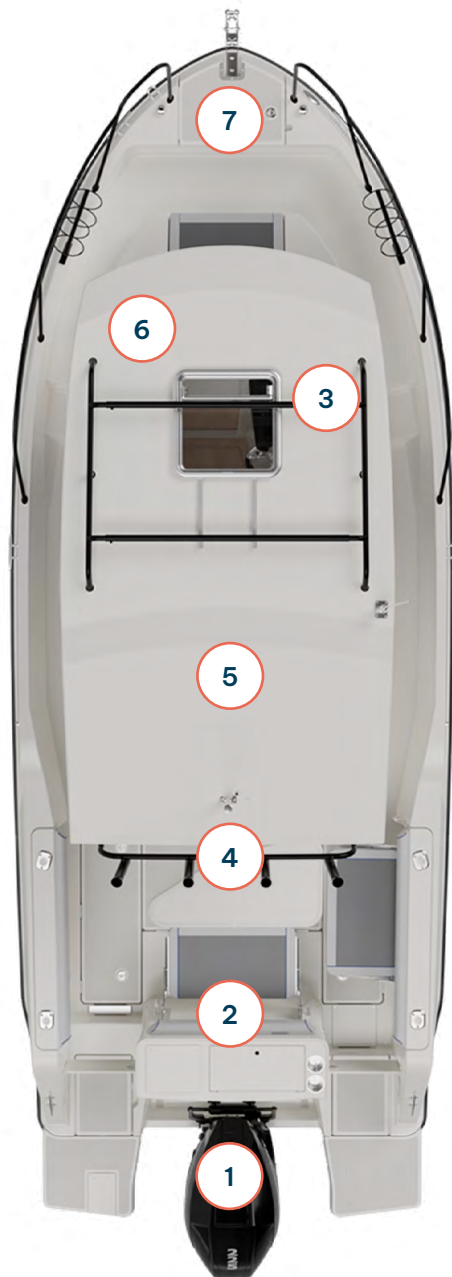

## Optional add-ons

### OB Engines

- Mercury 225 V6

### Cabin Comfort Pack

- Berth Filler/Cushions
- Interior Curtains
- Starboard passenger flip seat

### Fish Pack

- Port & Starboard Fish Locker with Pumpout
- Extra Rod holders (2)
- Raw Water Washdown with Faucet
- Port & Starboard Toe Rails
- Fish Station Gunnel Pad
- Fishing Station with Livewell System

### Convenience Options

- Hardtop Spotlight
- VHF Simrad
- GPS 9" Simrad NSS evo3s with Mercury VesselView
- Starboard and Aft Flip Seats
- Bow Electrical Windlass
- Bow Thruster
- Bow Cushion
- Refrigerator
- Sea Toilet with Front Portlight & Cabin Door

## Features

1. Award winning Mercury engine
2. Premium stitched upholstery
3. Pilot & Co-Pilot Seat
4. Ample Rod Storage
5. Spacious fishing cockpit that doubles as dining area
6. Large berth
7. Anchor locker and windlass



# T23 Pilothouse

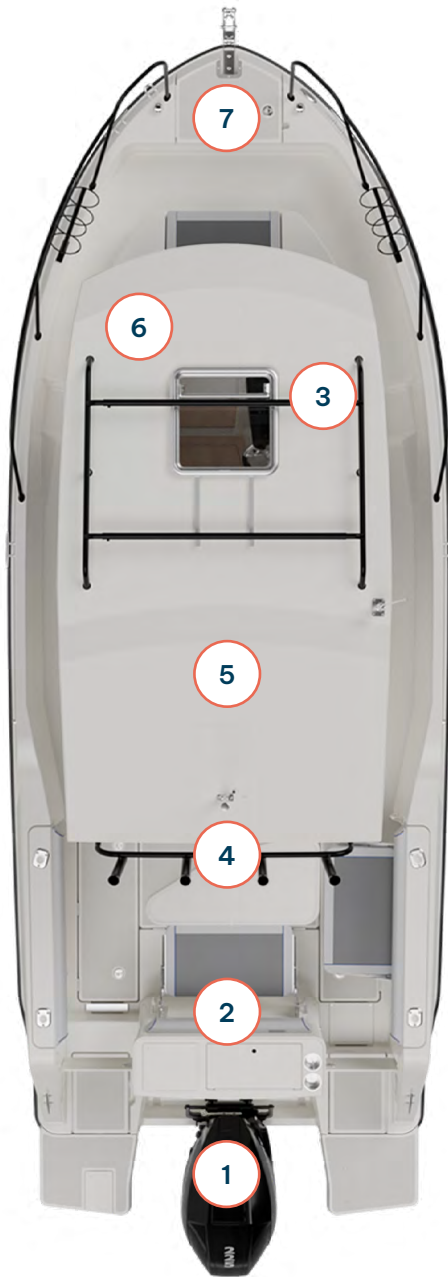

## Engine performance data

### Outboard

#### 175 HP Mercury V6 FS XL

Cruise mph	24.2
WOT mph	38.3
Propeller	Enertia 15.3x14P
Range	137 nm
Weight as tested	4,832 lbs

#### 225 HP Mercury V6 FS XL

Cruise mph	25.7
WOT mph	42.3
Propeller	Enertia 15.3x14P
Range	135 nm
Weight as tested	4,832 lbs

*This information is provided for comparison purposes and is intended to show relative performance between different boats and engine options. A specific boat's performance will be affected by water and weather conditions, altitude, condition of boat, actual load, engine and propeller. Engine performance data is based on boat in cruise load weight condition. Cruise load weight condition consists of boat with typical options, full tanks, all safety gear, two passengers and typical storage. Cruising range based on cruise speed at cruise load with 10% fuel reserve at rated range.*





# T25 Pilothouse

**Trophy**

LENGTH OVERALL (LOA)	25' 4"	7.72 M
WIDTH (BEAM)	9' 6"	2.89 M
MAX PEOPLE CAPACITY	10	10
MAX HORSEPOWER	350 HP	350 HP
DEADRISE	17°	17°
APPROX WEIGHT W/ STANDARD ENGINE	5,367 LBS	2,653 KG
MAX PEOPLE WEIGHT	1,650 LBS	1,202 KG
FUEL CAPACITY	86 GAL	325 L
DRAFT MIN	2'	0.61 M
DRAFT MAX	3' 7"	1.09 M
HEIGHT1	9' 8"	2.94 M
HEIGHT1 W/ OPTIONS	10' 10"	3.30 M

Specification dimensions are approximate and subject to variance.

<sup>1</sup> With trailer/tower folded

<sup>2</sup> Outboard motor in down position and trailer tongue swung to side.

Colors, graphics and some equipment shown, subject to change without notice.

## Standard features

### Cockpit

Cockpit Rod Storage  
Rod holders  
Self Bailing Cockpit  
Transom Door  
Cockpit Flood Light  
Electric & Manual Bilge Pump

### Equipment

Shore Power 110v  
Active Trim  
Dual Battery System  
CO Monitor  
Smoke Detector  
Electric & Manual Bilge Pump  
Starboard Windshield Wiper  
OB Pre-Rigging

### Engine

Mercury 225 V6

### Steering

Hydraulic Steering  
Tilt Steering

### Helm

Smartcraft Speedometer/  
Tachometer  
12v electrical socket

### Hull & Deck

Swim Ladder  
Swim Platform  
Anchor Locker  
Navigation Lights

### Cabin

Storage below Berth  
Cabin Lights  
Pilot & Co-pilot Seat  
Starboard Pilothouse Entry Door

### USA Premium Package

Bow Roller  
Roof Hatch  
Stereo Fusion with 4 speakers  
Port & Starboard Fish Locker  
with Pumpout  
Raw Water Washdown with Faucet  
Port & Starboard Toe Rails  
Fish Station Gunnel Pad  
Fishing Station with Livewell System  
Interior Rod Racks  
Sink with Tap  
Enclosed Sea toilet  
Opening Portlight  
Windshield Wash  
Shore Power 110v

Simrad GPS/Chart Plotter 7" NSS evo3  
with HDI Transducer -  
Mounted in Cabin  
VesselView Link digital interface  
Bow Thruster  
Bow Electrical Windlass  
Hardtop Spotlight



# T25 Pilothouse

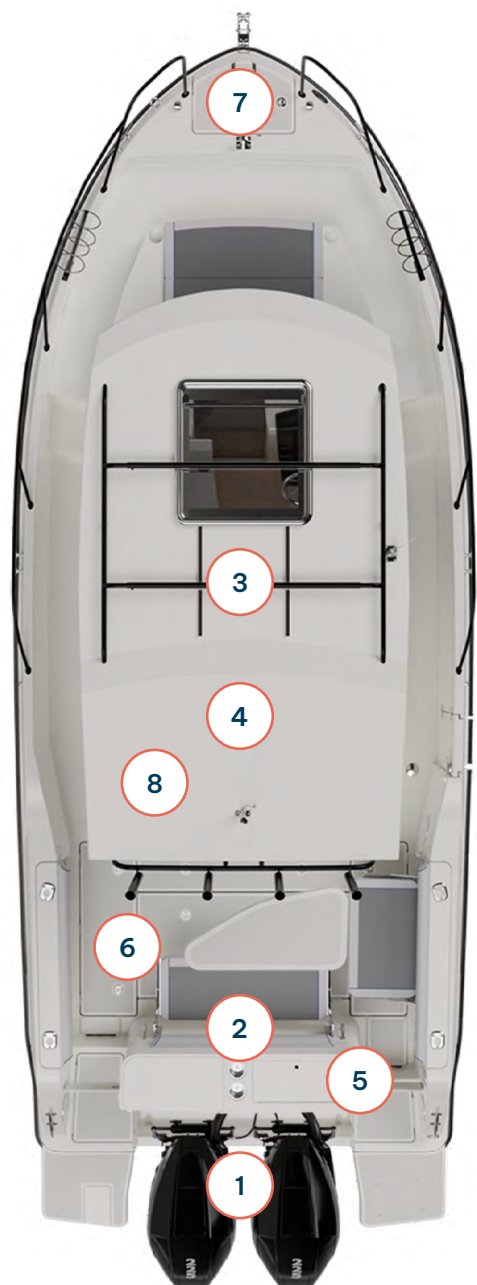

## Optional add-ons

### OB Engines

- Mercury Dual Helm 225 V6
- 300 HP XXL V8 Verado AMS
- Dual Helm 300HP XXL V8 DTS, SC w/Hydraulic Steering
- Twin 175HP XL V6 DTS, SC & Hydraulic/Electric Power Steering

### Comfort Pack

- LED Courtesy Lights
- Cockpit Shower
- Aft Flip Down Seat
- Starboard Flip Down Seat
- Cockpit Table
- Berth Filler/Cushions
- Interior Curtains
- Refrigerator

### Convenience Options

- Radar Simrad Halo 20 Dome
- VHF Simrad
- Bow Mooring Bollard
- Zipwake Dynamic Trim-Control System
- Exterior Cockpit GPS 7" Simrad NSS evo3 (Single Helm Rigging)
- Exterior Cockpit GPS 7" Simrad NSS evo3 (Dual Helm Rigging)
- Explorer rails
- Bimini/Complete Enclosed Canvas
- Diesel Heater w/Defogger

## Features

1. Award winning Mercury engine
2. Premium stitched upholstery
3. Free-Flowing Cabin
4. Spacious fishing cockpit that doubles as a dining area
5. Fishing livewell system
6. Large fish lockers
7. Anchor locker and windlass
8. Galley



# T25 Pilothouse

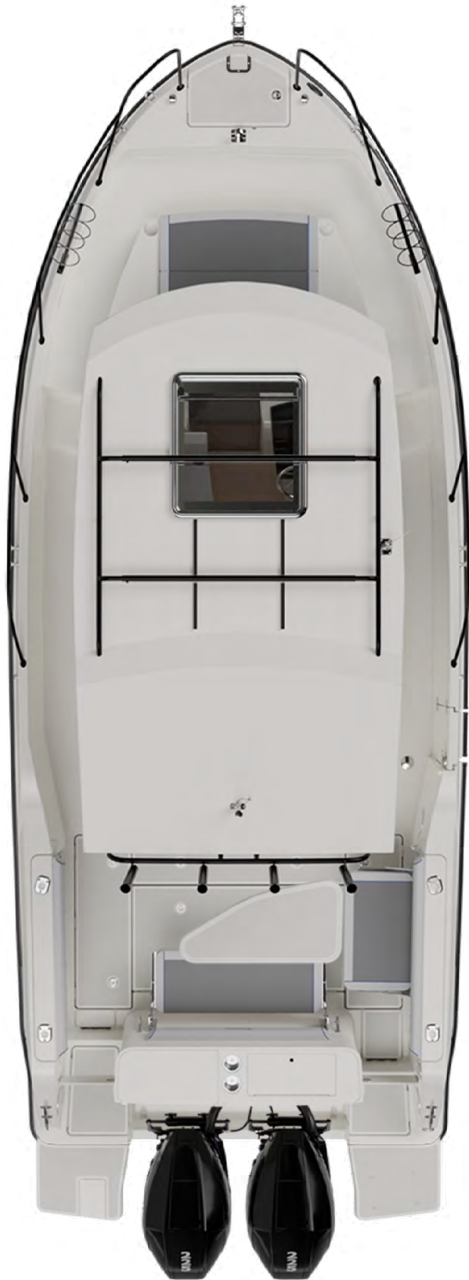

## Engine performance data

### Outboard

#### 225 HP Mercury V6 FS XL

Cruise mph	22.2
WOT mph	37.0
Propeller	Enertia 15.3x14P
Range	205 nm
Weight as tested	6,834 lbs

#### 300 HP Mercury V8 FS XL

Cruise mph	21.8
WOT mph	42.3
Propeller	Enertia 15.3x14P
Range	157 nm
Weight as tested	6,894 lbs

*This information is provided for comparison purposes and is intended to show relative performance between different boats and engine options. A specific boat's performance will be affected by water and weather conditions, altitude, condition of boat, actual load, engine and propeller. Engine performance data is based on boat in cruise load weight condition. Cruise load weight condition consists of boat with typical options, full tanks, all safety gear, two passengers and typical storage. Cruising range based on cruise speed at cruise load with 10% fuel reserve at rated range.*





**BAYLINER.COM**   